



Policies & Services	3
Introduction to Estey	4
2.5" Weld Frame	
About the 2.5" Weld Frame System	5
Shelving Units	6-12
Frames & Frame Accessories	13
Base Shelves	14-15
Shelves, Brackets, Dividers, Shims	16
Periodical, Sloped, Storage and Integral Back Shelves	17
Storage, Reference and Specialty Shelves	18
Cabinet, Browsing Boxes & Accessories	19
Newspaper Rack, Wall Hung Columns & Accessories	20
Book Supports, Fillers, End Brackets	21
Backstops, Base Filler Closures	22
Canopy Tops & Accessories	23
Gussets & Fillers	24
End Panels and Backs	25
Designer Series	
Display Units & Divider Units	26-30
Uprights & Accessories	31
Shelves, Dividers, Brackets, Struts	32
Cabinet, Newspaper Rack & Accessories	33
Specialty Shelves	34-35
Book Supports, Fillers, Backstops	36
Wall Hung Columns, Miscellaneous Accessories	37
Canopy Tops, Brackets, Signage, Gussets	38
End Panels & Backs	39
2" Weld Frame	
About the 2" Weld Frame System	40
Shelving Units	41-47
Frames & Frame Accessories	48
Base Shelves	49-50
Shelves, Brackets, Dividers, Shims	51
Periodical, Sloped, Storage and Integral Back Shelves	52
Storage, Reference and Specialty Shelves	53
Cabinet, Browsing Boxes & Accessories	54
Newspaper Rack, Wall Hung Columns & Accessories	55
Book Supports, Fillers, End Brackets	56
Backstops, Base Filler Closures	57
Canopy Tops & Accessories	58
Gussets & Fillers	59
End Panels and Backs	60
A-Frame	
Shelving Units	61
Accessories	62

POLICY AND SERVICES

PRICING: All prices are F.O.B. Tenssco Corp's Facility in Dickson, Tennessee. All orders are subject to final acceptance at the Home Office, Dickson, Tennessee. Prices subject to change without notice. Tenssco has the right to make product design changes at any time. Tenssco's prices do not include sales, use, excise or similar taxes. Consequently, in addition to the prices specified herein, the amount of any present or future sales, use, excise or similar tax applicable to the manufacture, sale, purchase or use of the goods sold hereunder shall be paid by Buyer. In lieu thereof, Buyer shall provide Seller with a tax exemption certificate acceptable to the applicable taxing authorities.

TERMS OF PAYMENT: Terms are Net 30 Days from date of shipment. A service charge of 1 1/2% per month will be charged for overdue invoices.

MINIMUM ORDERS: Minimum order is \$15.00.

SPECIFICATIONS: Tenssco reserves the right to change any product specifications contained in this price list.

FREIGHT CHARGES: All shipments will be made freight collect unless otherwise specified. If freight is prepared, it will be added to the invoice or billed separately, depending on arrangements. On shipments by parcel post, the postage will be added to the invoice. All routing will be done solely by the Home Office. If purchaser does not accept delivery of merchandise when ready for shipment, storage fees will be charged to the purchaser.

WEIGHT: Weights shown are approximate.

FREIGHT CLAIMS: Claims for shortages must be made in writing to the Home Office within 5 business days from receipt of shipment. Claims for damaged or lost material must be filed with the carrier.

CAUTION: When you give delivering carrier a clear receipt for a shipment in which there is damaged merchandise or a shortage, the carrier is relieved of further responsibility. Claims for damage or shortage must be filed by you with the delivering carrier. Tenssco will not accept return of merchandise damaged in transit. Your claim is with the delivering carrier.

PARTIAL SHIPMENTS: Tenssco reserves the right to make delivery in installments unless otherwise expressly stated herein. All such installments shall be separately invoiced and paid for when due, without regard to subsequent deliveries. Delay in delivery of all installments shall not relieve Buyer of its obligations to accept remaining deliveries.

SHIPPING TIME: Shipping dates are estimates only, based on standard manufacturing times. Tenssco makes every effort to meet shipping date requests, but will not be held liable for missed shipping dates. Once items are shipped, Tenssco is not responsible for delays caused by the delivering carrier. This includes, but is not limited to, delays in installation proceedings due to slow delivery by carrier.

CANCELLATIONS & RETURNS: Orders for "Special" items are not subject to change or cancellation. Special colors and textured colors cannot be returned. All returns are subject to approval. No return merchandise will be accepted without written consent of the General Office, Dickson, Tennessee. All returned shipments are subject to a handling charge of 25% plus all transportation charges incurred by Tenssco unless Tenssco is at fault. Once production of "Special" items has begun, cancellation of order is subject to Tenssco approval. A 15% surcharge will be assessed to approved cancelled items.

CODE RESTRICTIONS: Local building codes vary. It is the purchaser's responsibility to determine that product installation is in accordance with local requirements.

LIMITED WARRANTY

Tenssco warrants goods purchased hereunder to be free of defects in materials and workmanship for a period of one (1) year from the date of shipment, hereunder. Tenssco's warranty shall not apply in the event goods are damaged as a result of misuse, abuse, neglect, accident, improper application, modification or repair by persons not authorized by Seller, where goods are damaged during shipment. **UNLESS CONSIDERED UNENFORCEABLE OR UNLAWFUL UNDER APPLICABLE LAW:**

- a. ALL IMPLIED WARRANTIES, INCLUDING BUT NOT LIMITED TO WARRANTIES OR MERCHANTABILITY AND FITNESS FOR A PARTICULAR PURPOSE ARE HEREBY EXCLUDED.
- b. BUYERS REMEDY, IF ANY, FOR ANY DEFECTIVE GOODS SHALL BE LIMITED TO A REFUND BY SELLER OR REPLACEMENT OF THE GOODS AT SELLER'S OPTION AND SHALL IN NO EVENT INCLUDE DAMAGES OF ANY KIND, WHETHER INCIDENTAL, CONSEQUENTIAL OR OTHERWISE.

NO GOODS ACCEPTED FOR RETURN WITHOUT PRIOR APPROVAL. Seller shall have the right to inspect any goods claimed to be defective at Buyer's place of business or require Buyer to return the goods to Seller for inspection on Seller's premises. Transportation charges covering returned goods will be borne by Seller only if such goods are proven to be defective, are covered by this warranty and are returned within the warranty period stated above.



Cantilever Library Shelving

Estey Cantilever Library Shelving is designed to be functional, versatile and aesthetically beautiful. Cantilever Library Shelving offers a 2" Weld Frame option and a 2.5" Weld Frame option.

Designer Series Shelving

European styling was the inspiration behind the Estey Designer Series Library Shelving.



A-Frame Display Shelving

A-Frame Display Shelving offers a clean, modern style, perfect for any library environment.

NOTE: MOST PRODUCTS AVAILABLE IN 24"W AT AN UPCHARGE OF 25%.

THE 2.5" WELD FRAME SYSTEM

Estey Weld Frame construction eliminates the need for sway bracing and separate starter/adder units.

All Units Feature:

- Upright slot spacing 1" on centers in a 6" repeat pattern for easy shelf alignment.
- Upright posts have 8 right angle bends for added strength.
- Six-point leveling system per double-face section; four-point leveling system per single face section (adjustable levelers provided on both base units).
- Base shelves available in one-piece pan, or in multiple-piece construction with kickplate(see below).
- Electrostatically applied/baked-on epoxy/polyester powder coated finish.

Basic Shelving Components:

- Welded frames
- Base brackets
- Base shelf
- Adjustable shelves and brackets
- Kickplate(s) (black powder coat finish)

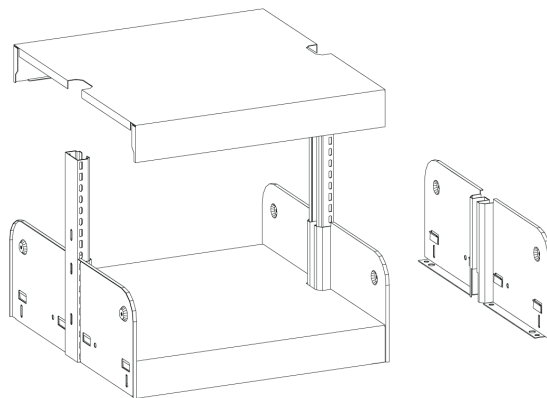

FIXED BASE SHELF

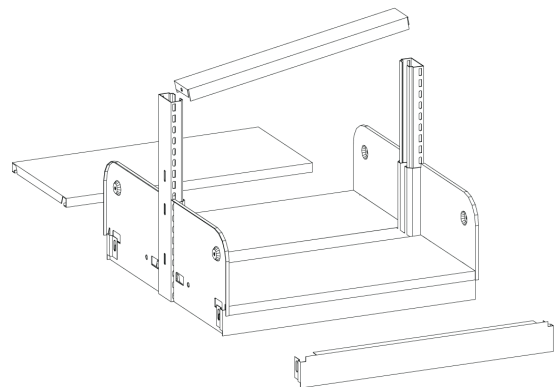

**ADJUSTABLE (KICKPLATE)
BASE SHELF**

NOTE: All shelf depths in this catalog are expressed in nominal sizes. Base shelf dimensions will actually be greater than those shown; all other shelf sizes will be 1" less. Contact factory for specific dimensions.

NOTE: MOST PRODUCTS AVAILABLE IN 24"W AT AN UPCHARGE OF 25%.

SINGLE FACE*

*All single face shelving must be wall anchored.



WF41080



WF61080



WF71080



WF81080



WF91080

FIXED BASE			ADJUSTABLE BASE			SHELF DEPTH	BASE DEPTH
CAT. NO.	WT.	PRICE	CAT. NO.	WT.	PRICE		
42" HIGH, 3 LEVELS							
WF41080	41	\$479.00	WA41080	41	\$473.00	8"	8"
WF41082	44	486.00	WA41082	44	475.00	8"	10"
WF41090	44	502.00	WA41090	44	498.00	9"	9"
WF41091	46	498.00	WA41091	45	491.00	9"	10"
WF41100	47	503.00	WA41100	47	502.00	10"	10"
WF41102	49	513.00	WA41102	48	498.00	10"	12"
WF41120	52	530.00	WA41120	51	527.00	12"	12"
66" HIGH, 5 LEVELS							
WF61080	59	\$631.00	WA61080	60	\$608.00	8"	8"
WF61082	63	638.00	WA61082	62	622.00	8"	10"
WF61090	63	670.00	WA61090	64	662.00	9"	9"
WF61091	66	661.00	WA61091	65	655.00	9"	10"
WF61100	69	673.00	WA61100	68	672.00	10"	10"
WF61102	70	683.00	WA61102	69	666.00	10"	12"
WF61120	76	716.00	WA61120	75	714.00	12"	12"
78" HIGH, 6 LEVELS							
WF71080	70	\$714.00	WA71080	70	\$689.00	8"	8"
WF71082	73	721.00	WA71082	72	701.00	8"	10"
WF71090	75	750.00	WA71090	76	752.00	9"	9"
WF71091	77	761.00	WA71091	76	745.00	9"	10"
WF71100	81	764.00	WA71100	80	763.00	10"	10"
WF71102	82	774.00	WA71102	81	771.00	10"	12"
WF71120	90	816.00	WA71120	89	813.00	12"	12"
84" HIGH, 7 LEVELS							
WF81080	77	\$780.00	WA81080	77	\$752.00	8"	8"
WF81082	80	787.00	WA81082	79	766.00	8"	10"
WF81090	82	822.00	WA81090	83	823.00	9"	9"
WF81091	85	835.00	WA81091	84	835.00	9"	10"
WF81100	89	839.00	WA81100	88	838.00	10"	10"
WF81102	90	849.00	WA81102	90	845.00	10"	12"
WF81120	100	899.00	WA81120	99	897.00	12"	12"
90" HIGH, 7 LEVELS							
WF91080	78	\$792.00	WA91080	78	\$763.00	8"	8"
WF91082	81	799.00	WA91082	80	777.00	8"	10"
WF91090	83	833.00	WA91090	84	836.00	9"	9"
WF91091	86	833.00	WA91091	85	829.00	9"	10"
WF91100	90	851.00	WA91100	89	850.00	10"	10"
WF91102	91	861.00	WA91102	91	858.00	10"	12"
WF91120	101	911.00	WA91120	100	908.00	12"	12"

30" wide units are available at the price listed. 24" wide units are available at a 25% upcharge. Contact factory for weights.
For 24" units, add "2" to end of catalog number (e.g. WF810802); for 30" units, add "3" (e.g. WF810803).

2.5" Weld Frame

NOTE: MOST PRODUCTS AVAILABLE IN 24"W AT AN UPCHARGE OF 25%.

DOUBLE FACE

FIXED BASE			ADJUSTABLE BASE			SHELF DEPTH	BASE DEPTH
CAT. NO.	WT.	PRICE	CAT. NO.	WT.	PRICE		
42" HIGH, 3 LEVELS							
WF42080	60	\$623.00	WA42080	64	\$655.00	8"	16"
WF42082	65	671.00	WA42082	67	673.00	8"	20"
WF42090	65	684.00	WA42090	68	692.00	9"	18"
WF42091	68	692.00	WA42091	71	707.00	9"	20"
WF42100	71	706.00	WA42100	74	724.00	10"	20"
WF42102	74	727.00	WA42102	76	729.00	10"	24"
WF42120	80	760.00	WA42120	83	779.00	12"	24"
66" HIGH, 5 LEVELS							
WF62080	92	\$878.00	WA62080	95	\$918.00	8"	16"
WF62082	97	945.00	WA62082	99	937.00	8"	20"
WF62090	100	990.00	WA62090	103	979.00	9"	18"
WF62091	103	988.00	WA62091	105	1,027.00	9"	20"
WF62100	109	1,014.00	WA62100	111	1,031.00	10"	20"
WF62102	112	1,035.00	WA62102	114	1,030.00	10"	24"
WF62120	124	1,102.00	WA62120	126	1,121.00	12"	24"
78" HIGH, 6 LEVELS							
WF72080	109	\$1,011.00	WA72080	113	\$1,056.00	8"	16"
WF72082	114	1,088.00	WA72082	117	1,072.00	8"	20"
WF72090	119	1,126.00	WA72090	122	1,128.00	9"	18"
WF72091	122	1,144.00	WA72091	124	1,158.00	9"	20"
WF72100	129	1,174.00	WA72100	132	1,191.00	10"	20"
WF72102	132	1,195.00	WA72102	134	1,214.00	10"	24"
WF72120	148	1,279.00	WA72120	150	1,298.00	12"	24"
84" HIGH, 7 LEVELS							
WF82080	123	\$1,128.00	WA82080	126	\$1,177.00	8"	16"
WF82082	128	1,214.00	WA82082	130	1,194.00	8"	20"
WF82090	134	1,263.00	WA82090	137	1,260.00	9"	18"
WF82091	137	1,310.00	WA82091	139	1,296.00	9"	20"
WF82100	146	1,318.00	WA82100	148	1,336.00	10"	20"
WF82102	149	1,339.00	WA82102	151	1,326.00	10"	24"
WF82120	167	1,439.00	WA82120	169	1,459.00	12"	24"
90" HIGH, 7 LEVELS							
WF92080	124	\$1,138.00	WA92080	127	\$1,189.00	8"	16"
WF92082	129	1,226.00	WA92082	131	1,205.00	8"	20"
WF92090	135	1,274.00	WA92090	138	1,271.00	9"	18"
WF92091	138	1,322.00	WA92091	140	1,309.00	9"	20"
WF92100	147	1,330.00	WA92100	149	1,347.00	10"	20"
WF92102	150	1,351.00	WA92102	152	1,337.00	10"	24"
WF92120	168	1,451.00	WA92120	170	1,471.00	12"	24"

30" wide units are available at the price listed. 24" wide units are available at a 25% upcharge. Contact factory for weights.
For 24" units, add "2" to end of catalog number (e.g. WF820802); for 30" units, add "3" (e.g. WF820803).



WF42080



WF62080



WF72080



WF82080



WF92080

2.5" Weld Frame

NOTE: MOST PRODUCTS AVAILABLE IN 24"W AT AN UPCHARGE OF 25%.

SINGLE FACE*

*All single face shelving must be wall anchored.



WBDF41080



WBDF61080



WBDF71080



WBDF81080



WBDF91080



WBDF01080

FIXED BASE			ADJUSTABLE BASE			SHELF DEPTH	BASE DEPTH
CAT. NO.	WT.	PRICE	CAT. NO.	WT.	PRICE		
42" HIGH, 3 LEVELS							
WBDF41100	62	\$656.00	WBDA41100	63	\$665.00	10"	10"
WBDF41102	63	670.00	WBDA41102	64	673.00	10"	12"
WBDF41103	64	668.00	WBDA41103	65	686.00	10"	13"
WBDF41120	66	692.00	WBDA41120	67	704.00	12"	12"
WBDF41130	69	713.00	WBDA41130	70	720.00	13"	13"
WBDF41133	73	752.00	WBDA41133	73	830.00	13"	16"
66" HIGH, 5 LEVELS							
WBDF61100	95	\$950.00	WBDA61100	96	\$955.00	10"	10"
WBDF61102	96	965.00	WBDA61102	97	963.00	10"	12"
WBDF61103	97	958.00	WBDA61103	98	977.00	10"	13"
WBDF61120	102	1,006.00	WBDA61120	103	1,018.00	12"	12"
WBDF61130	106	1,026.00	WBDA61130	107	1,043.00	13"	13"
WBDF61133	111	1,077.00	WBDA61133	111	1,151.00	13"	16"
78" HIGH, 6 LEVELS							
WBDF71100	113	\$1,103.00	WBDA71100	114	\$1,107.00	10"	10"
WBDF71102	114	1,103.00	WBDA71102	115	1,116.00	10"	12"
WBDF71103	115	1,110.00	WBDA71103	116	1,128.00	10"	13"
WBDF71120	122	1,169.00	WBDA71120	123	1,163.00	12"	12"
WBDF71130	127	1,194.00	WBDA71130	128	1,212.00	13"	13"
WBDF71133	131	1,245.00	WBDA71133	131	1,319.00	13"	16"
84" HIGH, 7 LEVELS							
WBDF81100	127	\$1,240.00	WBDA81100	128	\$1,242.00	10"	10"
WBDF81102	129	1,255.00	WBDA81102	129	1,250.00	10"	12"
WBDF81103	130	1,245.00	WBDA81103	130	1,264.00	10"	13"
WBDF81120	138	1,317.00	WBDA81120	139	1,306.00	12"	12"
WBDF81130	143	1,370.00	WBDA81130	144	1,364.00	13"	13"
WBDF81133	148	1,396.00	WBDA81133	148	1,470.00	13"	16"
90" HIGH, 7 LEVELS							
WBDF91100	128	\$1,239.00	WBDA91100	129	\$1,253.00	10"	10"
WBDF91102	130	1,250.00	WBDA91102	130	1,263.00	10"	12"
WBDF91103	131	1,257.00	WBDA91103	131	1,275.00	10"	13"
WBDF91120	139	1,329.00	WBDA91120	140	1,319.00	12"	12"
WBDF91130	144	1,358.00	WBDA91130	145	1,375.00	13"	13"
WBDF91133	149	1,407.00	WBDA91133	149	1,483.00	13"	16"
93" HIGH, 8 LEVELS							
WBDF01100	144	\$1,484.00	WBDA01100	144	\$1,498.00	10"	10"
WBDF01102	145	1,497.00	WBDA01102	146	1,506.00	10"	12"
WBDF01103	146	1,504.00	WBDA01103	146	1,520.00	10"	13"
WBDF01120	156	1,562.00	WBDA01120	156	1,575.00	12"	12"
WBDF01130	162	1,620.00	WBDA01130	163	1,638.00	13"	13"
WBDF01133	166	1,670.00	WBDA01133	166	1,744.00	13"	16"

30" wide units are available at the price listed. 24" wide units are available at a 25% upcharge. Contact factory for weights. For 24" units, add "2" to end of catalog number (e.g. WBDF811002); for 30" units, add "3" (e.g. WBDF811003).

All units come with 5 dividers per shelf. Dividers are adjustable on 1" centers.

NOTE: MOST PRODUCTS AVAILABLE IN 24"W AT AN UPCHARGE OF 25%.

DOUBLE FACE



WBDF42100



WBDF62100

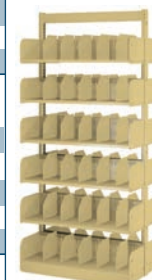

WBDF72100



WBDF82100



WBDF92100



WBDF102100

FIXED BASE			ADJUSTABLE BASE			SHELF DEPTH	BASE DEPTH
CAT. NO.	WT.	PRICE	CAT. NO.	WT.	PRICE		
42" HIGH, 3 LEVELS							
WBDF42100	106	\$1,050.00	WBDA42100	107	\$1,068.00	10"	20"
WBDF42102	109	1,077.00	WBDA42102	110	1,092.00	10"	24"
WBDF42103	111	1,078.00	WBDA42103	112	1,109.00	10"	26"
WBDF42120	115	1,118.00	WBDA42120	116	1,148.00	12"	24"
WBDF42130	120	1,163.00	WBDA42130	121	1,175.00	13"	26"
WBDF42133	128	1,236.00	WBDA42133	129	1,250.00	13"	32"
66" HIGH, 5 LEVELS							
WBDF62100	167	\$1,606.00	WBDA62100	169	\$1,617.00	10"	20"
WBDF62102	170	1,633.00	WBDA62102	171	1,641.00	10"	24"
WBDF62103	172	1,628.00	WBDA62103	173	1,659.00	10"	26"
WBDF62120	183	1,716.00	WBDA62120	184	1,746.00	12"	24"
WBDF62130	191	1,794.00	WBDA62130	192	1,792.00	13"	26"
WBDF62133	199	1,882.00	WBDA62133	206	1,912.00	13"	32"
78" HIGH, 6 LEVELS							
WBDF72100	199	\$1,890.00	WBDA72100	201	\$1,897.00	10"	20"
WBDF72102	203	1,893.00	WBDA72102	204	1,922.00	10"	24"
WBDF72103	204	1,910.00	WBDA72103	206	1,939.00	10"	26"
WBDF72120	218	2,021.00	WBDA72120	219	2,017.00	12"	24"
WBDF72130	227	2,078.00	WBDA72130	229	2,106.00	13"	26"
WBDF72133	236	2,167.00	WBDA72133	237	2,164.00	13"	32"
84" HIGH, 7 LEVELS							
WBDF82100	228	\$2,158.00	WBDA82100	229	\$2,163.00	10"	20"
WBDF82102	231	2,156.00	WBDA82102	232	2,187.00	10"	24"
WBDF82103	233	2,173.00	WBDA82103	234	2,204.00	10"	26"
WBDF82120	249	2,310.00	WBDA82120	249	2,283.00	12"	24"
WBDF82130	260	2,418.00	WBDA82130	262	2,404.00	13"	26"
WBDF82133	268	2,464.00	WBDA82133	270	2,456.00	13"	32"
90" HIGH, 7 LEVELS							
WBDF92100	229	\$2,141.00	WBDA92100	230	\$2,174.00	10"	20"
WBDF92102	232	2,167.00	WBDA92102	233	2,198.00	10"	24"
WBDF92103	234	2,184.00	WBDA92103	235	2,215.00	10"	20"
WBDF92120	250	2,322.00	WBDA92120	251	2,313.00	12"	24"
WBDF92130	261	2,386.00	WBDA92130	263	2,415.00	13"	26"
WBDF92133	269	2,477.00	WBDA92133	271	2,468.00	13"	32"
93" HIGH, 8 LEVELS							
WBDF02100	258	\$2,514.00	WBDA02100	259	\$2,548.00	10"	20"
WBDF02102	261	2,541.00	WBDA02102	262	2,572.00	10"	24"
WBDF02103	263	2,559.00	WBDA02103	264	2,590.00	10"	20"
WBDF02120	283	2,677.00	WBDA02120	284	2,705.00	12"	24"
WBDF02130	293	2,766.00	WBDA02130	296	2,824.00	13"	26"
WBDF02133	303	2,885.00	WBDA02133	304	2,874.00	13"	32"

30" wide units are available at the price listed. 24" wide units are available at a 25% upcharge. Contact factory for weights. For 24" units, add "2" to end of catalog number (e.g. WBDF821002); for 30" units, add "3" (e.g. WBDF821003).

All units come with 5 dividers per shelf. Dividers are adjustable on 1" centers.

2.5" Weld Frame

NOTE: MOST PRODUCTS AVAILABLE IN 24"W AT AN UPCHARGE OF 25%.

SINGLE FACE*

*All single face shelving must be wall anchored.

2.5" Weld Frame



WFIB41080



WFIB61080



WFIB71080



WFIB81080



WFIB91080

FIXED BASE			ADJUSTABLE BASE			SHELF DEPTH	BASE DEPTH
CAT. NO.	WT.	PRICE	CAT. NO.	WT.	PRICE		
42" HIGH, 3 LEVELS							
WFIB41080	42	\$545.00	WAIB41080	42	\$525.00	8"	8"
WFIB41082	44	538.00	WAIB41082	44	536.00	8"	10"
WFIB41090	44	546.00	WAIB41090	45	552.00	9"	9"
WFIB41091	45	549.00	WAIB41091	46	551.00	9"	10"
WFIB41100	47	551.00	WAIB41100	47	554.00	10"	10"
WFIB41102	48	566.00	WAIB41102	49	571.00	10"	12"
WFIB41120	52	601.00	WAIB41120	53	606.00	12"	12"
66" HIGH, 5 LEVELS							
WFIB61080	62	\$745.00	WAIB61080	62	\$727.00	8"	8"
WFIB61082	64	736.00	WAIB61082	64	738.00	8"	10"
WFIB61090	65	756.00	WAIB61090	66	763.00	9"	9"
WFIB61091	67	759.00	WAIB61091	67	763.00	9"	10"
WFIB61100	70	766.00	WAIB61100	70	769.00	10"	10"
WFIB61102	71	781.00	WAIB61102	72	786.00	10"	12"
WFIB61120	78	851.00	WAIB61120	79	856.00	12"	12"
78" HIGH, 6 LEVELS							
WFIB71080	73	\$847.00	WAIB71080	73	\$833.00	8"	8"
WFIB71082	75	842.00	WAIB71082	76	846.00	8"	10"
WFIB71090	78	871.00	WAIB71090	79	878.00	9"	9"
WFIB71091	79	871.00	WAIB71091	79	871.00	9"	10"
WFIB71100	83	880.00	WAIB71100	83	883.00	10"	10"
WFIB71102	84	895.00	WAIB71102	85	899.00	10"	12"
WFIB71120	93	982.00	WAIB71120	94	987.00	12"	12"
84" HIGH, 7 LEVELS							
WFIB81080	81	\$937.00	WAIB81080	81	\$923.00	8"	8"
WFIB81082	83	932.00	WAIB81082	83	934.00	8"	10"
WFIB81090	86	963.00	WAIB81090	87	970.00	9"	9"
WFIB81091	87	977.00	WAIB81091	88	965.00	9"	10"
WFIB81100	92	977.00	WAIB81100	92	980.00	10"	10"
WFIB81102	93	992.00	WAIB81102	94	997.00	10"	12"
WFIB81120	104	1,097.00	WAIB81120	104	1,102.00	12"	12"
90" HIGH, 7 LEVELS							
WFIB91080	82	\$953.00	WAIB91080	82	\$937.00	8"	8"
WFIB91082	84	944.00	WAIB91082	84	946.00	8"	10"
WFIB91090	87	976.00	WAIB91090	88	983.00	9"	9"
WFIB91091	88	977.00	WAIB91091	89	977.00	9"	10"
WFIB91100	93	989.00	WAIB91100	93	991.00	10"	10"
WFIB91102	94	1,004.00	WAIB91102	95	1,008.00	10"	12"
WFIB91120	105	1,109.00	WAIB91120	105	1,114.00	12"	12"

Units come with one wire divider per shelf level.

30" wide units are available at the price listed. 24" wide units are available at a 25% upcharge. Contact factory for weights.

For 24" units, add "2" to end of catalog number (e.g. WFIB810802); for 30" units, add "3" (e.g. WFIB810803).

CAT. NO.	W	D	H	WT.	PRICE
EXTRA DIVIDERS					
EWD-1	3/16	8	6 1/2	0.4	\$17.50
EWD-2	3/16	12	6 1/2	0.6	19.60

NOTE: MOST PRODUCTS AVAILABLE IN 24"W AT AN UPCHARGE OF 25%.

DOUBLE FACE

FIXED BASE			ADJUSTABLE BASE			SHELF DEPTH	BASE DEPTH
CAT. NO.	WT.	PRICE	CAT. NO.	WT.	PRICE		
42" HIGH, 3 LEVELS							
WFIB42080	66	\$837.00	WAIB42080	67	\$799.00	8"	16"
WFIB42082	69	809.00	WAIB42082	71	813.00	8"	20"
WFIB42090	70	823.00	WAIB42090	71	839.00	9"	18"
WFIB42091	72	830.00	WAIB42091	74	833.00	9"	20"
WFIB42100	75	841.00	WAIB42100	77	844.00	10"	20"
WFIB42102	79	869.00	WAIB42102	80	882.00	10"	24"
WFIB42120	86	939.00	WAIB42120	87	954.00	12"	24"
66" HIGH, 5 LEVELS							
WFIB62080	100	\$1,212.00	WAIB62080	102	\$1,168.00	8"	16"
WFIB62082	104	1,180.00	WAIB62082	105	1,183.00	8"	20"
WFIB62090	108	1,220.00	WAIB62090	109	1,235.00	9"	18"
WFIB62091	110	1,221.00	WAIB62091	112	1,229.00	9"	20"
WFIB62100	116	1,239.00	WAIB62100	118	1,242.00	10"	20"
WFIB62102	120	1,267.00	WAIB62102	121	1,282.00	10"	24"
WFIB62120	134	1,407.00	WAIB62120	135	1,422.00	12"	24"
78" HIGH, 6 LEVELS							
WFIB72080	119	\$1,404.00	WAIB72080	121	\$1,359.00	8"	16"
WFIB72082	123	1,372.00	WAIB72082	125	1,371.00	8"	20"
WFIB72090	129	1,415.00	WAIB72090	130	1,439.00	9"	18"
WFIB72091	130	1,422.00	WAIB72091	132	1,424.00	9"	20"
WFIB72100	138	1,444.00	WAIB72100	140	1,447.00	10"	20"
WFIB72102	142	1,472.00	WAIB72102	143	1,487.00	10"	24"
WFIB72120	159	1,647.00	WAIB72120	160	1,662.00	12"	24"
84" HIGH, 7 LEVELS							
WFIB82080	135	\$1,581.00	WAIB82080	136	\$1,534.00	8"	16"
WFIB82082	138	1,541.00	WAIB82082	140	1,547.00	8"	20"
WFIB82090	145	1,600.00	WAIB82090	146	1,628.00	9"	18"
WFIB82091	147	1,607.00	WAIB82091	149	1,609.00	9"	20"
WFIB82100	156	1,633.00	WAIB82100	158	1,636.00	10"	20"
WFIB82102	160	1,661.00	WAIB82102	161	1,677.00	10"	24"
WFIB82120	181	1,871.00	WAIB82120	182	1,886.00	12"	24"
90" HIGH, 7 LEVELS							
WFIB92080	136	\$1,590.00	WAIB92080	137	\$1,546.00	8"	16"
WFIB92082	139	1,558.00	WAIB92082	141	1,560.00	8"	20"
WFIB92090	146	1,613.00	WAIB92090	147	1,638.00	9"	18"
WFIB92091	148	1,620.00	WAIB92091	150	1,621.00	9"	20"
WFIB92100	157	1,645.00	WAIB92100	159	1,651.00	10"	20"
WFIB92102	161	1,673.00	WAIB92102	162	1,687.00	10"	24"
WFIB92120	182	1,883.00	WAIB92120	183	1,894.00	12"	24"



WFIB42080



WFIB62080

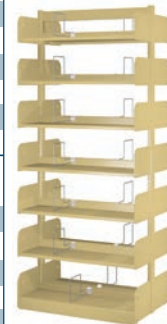

WFIB72080



WFIB82080



WFIB92080

2.5" Weld Frame

Units come with one wire divider per shelf level.
 30" wide units are available at the price listed. 24" wide units are available at a 25% upcharge. Contact factory for weights.
 For 24" units, add "2" to end of catalog number (e.g. WFIB820802); for 30" units, add "3" (e.g. WFIB820803).

CAT. NO.	W	D	H	WT.	PRICE
EXTRA DIVIDERS					
EWD-1	3/16	8	6 1/2	0.4	\$17.50
EWD-2	3/16	12	6 1/2	0.6	19.60

NOTE: MOST PRODUCTS AVAILABLE IN 24"W AT AN UPCHARGE OF 25%.

PERIODICAL DISPLAY UNITS

Pivoting periodical shelving with flat storage shelf.
With 12" storage shelves & 12" fixed base single face or 24" fixed base double face.



WP61120



WP62120

24" wide units are available at a 25% upcharge. Contact factory for weights.

CAT. NO.	SLOPING SHELVES	STORAGE LEVELS	W	D	H	WT.	PRICE
SINGLE FACE*							
WP411203†	3	3	30	12	42	68.0	\$755.00
WP611203	4	4	30	12	66	88.0	963.00
WP711203	5	5	30	12	78	107.0	1,140.00
WP811203	5	5	30	12	84	108.0	1,143.00
WP911203	6	6	30	12	90	124.0	1,275.00
WP41120†	3	3	36	12	42	77.0	780.00
WP61120	4	4	36	12	66	100.0	965.00
WP71120	5	5	36	12	78	122.0	1,140.00
WP81120	5	5	36	12	84	122.0	1,146.00
WP91120	6	6	36	12	90	141.0	1,310.00
DOUBLE FACE							
WP421203†	6	6	30	24	42	114.0	\$1,197.00
WP621203	8	8	30	24	66	150.0	1,543.00
WP721203	10	10	30	24	78	183.0	1,851.00
WP821203	10	10	30	24	84	184.0	1,856.00
WP921203**	12	12	30	24	90	216.0	2,167.00
WP42120†	6	6	36	24	42	130.0	1,211.00
WP62120	8	8	36	24	66	171.0	1,548.00
WP72120	10	10	36	24	78	211.0	1,875.00
WP82120	10	10	36	24	84	211.0	1,882.00
WP92120**	12	12	36	24	90	248.0	2,167.00

† A canopy top will not fit on 42" high units.

*All single face shelving must be wall anchored.

**Overhead top bracing recommended.

DISPLAY SHELF UNITS

Ideal for displaying various periodicals, new books or other media items. Lower shelves are sloped 10° for better visualization



WFDS636



WFDD636

30" wide units are available at the price listed. 24" wide units are available at a 25% upcharge. Contact factory for weights.

CAT. NO.	SLOPING SHELVES	STORAGE LEVELS	W	D	H	WT.	PRICE
SINGLE FACE*							
WFDS436	0	3	36	17	42	64.0	\$822.00
WFDS636	2	3	36	17	66	98.0	1,169.00
WFDS836	3	4	36	17	84	127.0	1,373.00
WFDS936**	3	4	36	17	90	130.0	1,403.00
DOUBLE FACE							
WFDD436	0	6	36	31	42	111.0	\$1,345.00
WFDD636	4	6	36	31	66	174.0	2,005.00
WFDD836	6	8	36	31	84	226.0	2,406.00
WFDD936**	6	8	36	31	90	235.0	2,391.00

*All single face shelving must be wall anchored.

**Overhead top bracing recommended.

NOTE: MOST PRODUCTS AVAILABLE IN 24"W AT AN UPCHARGE OF 25%.

WELDED FRAMES

CAT. NO.	DESCRIPTION	W	D	H	WT.	PRICE
W4230		30	2 1/2	42	14.2	\$188.00
W5430		30	2 1/2	54	16.0	225.00
W6630		30	2 1/2	66	19.4	220.00
W7830		30	2 1/2	78	22.0	242.00
W8430		30	2 1/2	84	23.0	248.00
W9030		30	2 1/2	90	24.0	260.00
W9330		30	2 1/2	93	25.0	377.00
W4236		36	2 1/2	42	15.3	188.00
W5436		36	2 1/2	54	15.5	225.00
W6636		36	2 1/2	66	20.0	220.00
W7836		36	2 1/2	78	24.0	242.00
W8436		36	2 1/2	84	24.0	248.00
W9036		36	2 1/2	90	25.0	260.00
W9336		36	2 1/2	93	26.0	377.00
W10836		36	2 1/2	108	27.0	389.00
W11236		36	2 1/2	112	27.0	431.00
SEISMIC SWAY BRACES						
SSBR6030A	For 66" and 78" frames	30	1	58	4.5	\$108.00
SSBR7330A	For 84", 90" and 93" frames	30	1	73	5.9	123.00
SSBR6036A	For 66" and 78" frames	36	1	58	4.5	100.00
SSBR7336A	For 84", 90" and 93" frames	36	1	73	5.9	114.00

24" wide units are available at a 25% upcharge. Contact factory for weights. For 24" units, add "2" to end of catalog number (e.g. W42302)
Special widths or heights are available. Contact factory for pricing.



WELDED FRAMES



SEISMIC SWAY BRACES

SEISMIC WELDED FRAMES

CAT. NO.	W	D	H	WT.	PRICE
SWF7830	30	2 1/2	78	27.0	\$388.00
SWF8430	30	2 1/2	84	31.0	392.00
SWF9030	30	2 1/2	90	32.0	392.00
SWF7836	36	2 1/2	78	29.0	388.00
SWF8436	36	2 1/2	84	31.0	392.00
SWF9036	36	2 1/2	90	32.0	392.00

Eliminates the need for sway braces.



WELDED FRAME EXTENDER

CAT. NO.	W	D	H	WT.	PRICE
WFEXT3618	36	2 1/2	18	9.2	\$270.00
WFEXT3624	36	2 1/2	24	11.2	241.00
WFEXT3630	36	2 1/2	30	13.9	259.00
WFEXT36xx	36	2 1/2	Varies	Varies	Contact Factory



Add to existing frames for more space. Available in a variety of sizes with a 12" minimum. Contact factory for pricing and weights on sizes not shown.

NOTE: MOST PRODUCTS AVAILABLE IN 24"W AT AN UPCHARGE OF 25%.

CLOSED BASE SHELVES - SINGLE FACE



Comes complete with base brackets. Kickplates for adjustable base shelves are furnished with black powder coat finish. If 30" shelves are desired, change the number "36" to "30" (e.g. WA3013A or WB3013A). Call factory for weights on 30" shelves.

CAT. NO.	W	D	H	WT.	PRICE
FOR FIXED BASE SHELVES					
WB3608A	36	8	3 5/16	12.2	\$166.00
WB3609A	36	9	3 5/16	13.1	173.00
WB3610A	36	10	3 5/16	15.4	173.00
WB3612A	36	12	3 5/16	16.6	183.00
WB3613A	36	13	3 5/16	17.4	209.00
WB3616A	36	16	3 5/16	20.0	227.00
FOR ADJUSTABLE BASE SHELVES					
WA3608A	36	8	3 5/16	12.4	\$157.00
WA3609A	36	9	3 5/16	13.9	178.00
WA3610A	36	10	3 5/16	14.6	174.00
WA3612A	36	12	3 5/16	16.0	182.00
WA3613A	36	13	3 5/16	16.9	204.00
WA3616A	36	16	3 5/16	19.0	280.00

CLOSED BASE SHELVES - DOUBLE FACE

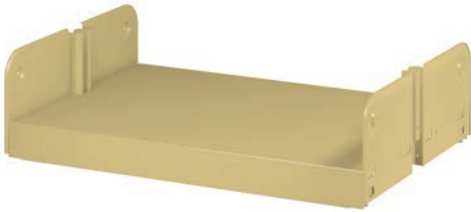

Comes complete with base brackets. Kickplates for adjustable base shelves are furnished with black powder coat finish. If 30" shelves are desired, change the number "36" to "30" (e.g. WA3013A or WB3013A). Call factory for weights on 30" shelves.

CAT. NO.	W	D	H	WT.	PRICE
FOR FIXED BASE SHELVES					
WB3616DA	36	16	3 5/16	18.0	\$171.00
WB3618A	36	18	3 5/16	19.9	222.00
WB3620A	36	20	3 5/16	23.0	241.00
WB3624A	36	24	3 5/16	26.0	262.00
WB3626A	36	26	3 5/16	28.0	302.00
WB3632A	36	32	3 5/16	33.0	306.00
FOR ADJUSTABLE BASE SHELVES					
WA3616DA	36	16	3 5/16	21.0	\$246.00
WA3618A	36	18	3 5/16	23.0	246.00
WA3620A	36	20	3 5/16	25.0	260.00
WA3624A	36	24	3 5/16	28.0	282.00
WA3626A	36	26	3 5/16	30.0	316.00
WA3632A	36	32	3 5/16	35.0	323.00

CLOSED BASE SHELVES WITH INTEGRAL BACK AND DIVIDERS - SINGLE FACE

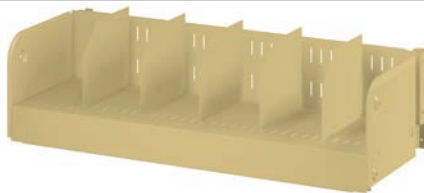

Slotted on 1" centers for dividers, with 5" backstop. Five adjustable dividers provided per shelf. Kickplates for adjustable base shelves are furnished with black powder coat finish. If 30" shelves are desired, change the number "36" to "30" (e.g. TBDF3010 or TBDA3010). Call factory for weights on 30" shelves.

CAT. NO.	W	D	H	WT.	PRICE
FOR FIXED BASE SHELVES					
TBDF3610	36	10	3 5/16	18.3	\$202.00
TBDF3612	36	12	3 5/16	19.5	216.00
TBDF3613	36	13	3 5/16	20.0	218.00
TBDF3616	36	16	3 5/16	25.0	269.00
FOR ADJUSTABLE BASE SHELVES					
TBDA3610	36	10	3 5/16	18.9	\$220.00
TBDA3612	36	12	3 5/16	20.0	230.00
TBDA3613	36	13	3 5/16	21.0	242.00
TBDA3616	36	16	3 5/16	25.0	344.00

CLOSED BASE SHELVES WITH INTEGRAL BACK AND DIVIDERS - DOUBLE FACE



Slotted on 1" centers for dividers, with 5" backstop. Five adjustable dividers provided per shelf. Kickplates for adjustable base shelves are furnished with black powder coat finish. If 30" shelves are desired, change the number "36" to "30" (e.g. TBDF3010 or TBDA3010). Call factory for weights on 30" shelves.

CAT. NO.	W	D	H	WT.	PRICE
FOR FIXED BASE SHELVES					
TBDF3620	36	20	3 5/16	34.0	\$337.00
TBDF3624	36	24	3 5/16	37.0	363.00
TBDF3626	36	26	3 5/16	39.0	372.00
TBDF3632	36	32	3 5/16	47.0	463.00
FOR ADJUSTABLE BASE SHELVES					
TBDA3620	36	20	3 5/16	35.0	\$369.00
TBDA3624	36	24	3 5/16	38.0	395.00
TBDA3626	36	26	3 5/16	40.0	415.00
TBDA3632	36	32	3 5/16	48.0	487.00

2.5" Weld Frame

NOTE: MOST PRODUCTS AVAILABLE IN 24"W AT AN UPCHARGE OF 25%.

INTEGRAL BACK BASE SHELVES - SINGLE FACE

CAT. NO.	W	D	H	WT.	PRICE
WIBBS3008A	30	8	3 5/16	10.2	\$185.00
WIBBS3009A	30	9	3 5/16	10.8	179.00
WIBBS3010A	30	10	3 5/16	12.0	176.00
WIBBS3012A	30	12	3 5/16	13.2	191.00
WIBBS3013A	30	13	3 5/16	14.2	208.00
WIBBS3016A	30	16	3 5/16	16.4	225.00
WIBBS3608A	36	8	3 5/16	11.2	185.00
WIBBS3609A	36	9	3 5/16	11.9	176.00
WIBBS3610A	36	10	3 5/16	13.2	177.00
WIBBS3612A	36	12	3 5/16	14.6	192.00
WIBBS3613A	36	13	3 5/16	15.5	209.00
WIBBS3616A	36	16	3 5/16	18.2	226.00
DIVIDER ONLY					
EWD-1	3/16	8	6 1/2	0.4	\$17.50
EWD-2	3/16	12	6 1/2	0.6	19.60



Includes one wire divider per opening and a 2" built-in backstop.
If adjustable base is required, change "WIBBS" to "WIBBSA" when ordering (e.g. WIBBSAwddA).
Call factory for adjustable base pricing and weights.

INTEGRAL BACK BASE SHELVES - DOUBLE FACE

CAT. NO.	W	D	H	WT.	PRICE
WIBBS3018A	30	18	3 5/16	19.6	\$284.00
WIBBS3020A	30	20	3 5/16	21.0	284.00
WIBBS3024A	30	24	3 5/16	25.0	312.00
WIBBS3026A	30	26	3 5/16	26.0	350.00
WIBBS3032A	30	32	3 5/16	31.0	379.00
WIBBS3618A	36	18	3 5/16	22.0	280.00
WIBBS3620A	36	20	3 5/16	24.0	286.00
WIBBS3624A	36	24	3 5/16	27.0	314.00
WIBBS3626A	36	26	3 5/16	29.0	349.00
WIBBS3632A	36	32	3 5/16	34.0	380.00
DIVIDER ONLY					
EWD-1	3/16	8	6 1/2	0.4	\$17.50
EWD-2	3/16	12	6 1/2	0.6	19.60

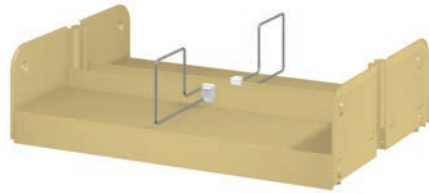

Includes one wire divider per opening and a 2" built-in backstop.
If adjustable base is required, change "WIBBS" to "WIBBSA" when ordering (e.g. WIBBSAwdddA).
Call factory for adjustable base pricing and weights.

SLOPING BASE SHELVES - SINGLE FACE

CAT. NO.	W	D	H	WT.	PRICE
WSB3009A	30	9	3 7/8	14.0	\$181.00
WSB3010A	30	10	3 7/8	14.3	181.00
WSB3012A	30	12	3 7/8	15.2	182.00
WSB3609A	36	9	3 7/8	13.5	181.00
WSB3610A	36	10	3 7/8	15.0	181.00
WSB3612A	36	12	3 7/8	15.2	182.00
VIDEO SLOPING BASE SHELVES (6 DIVIDERS INCLUDED)					
VC3012A	30	12	3 7/8	18.7	\$248.00
VC3612A	36	12	3 7/8	19.7	249.00



WSB3612A

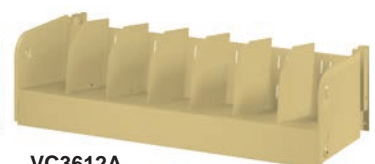

VC3612A

Sloping Base Shelves and Video Sloping Base Shelves are sloped at 9°, aiding visually those items displayed on the bottom shelf. Video Sloping Base Shelves are slotted on 1" centers for dividers, with 5" integral backstop; six adjustable dividers are provided.

SLOPING BASE SHELVES - DOUBLE FACE

CAT. NO.	W	D	H	WT.	PRICE
WSB3018A	30	18	3 7/8	24.0	\$291.00
WSB3020A	30	20	3 7/8	25.0	309.00
WSB3024A	30	24	3 7/8	31.0	311.00
WSB3618A	36	18	3 7/8	23.0	291.00
WSB3620A	36	20	3 7/8	26.0	307.00
WSB3624A	36	24	3 7/8	31.0	311.00
VIDEO SLOPING BASE SHELVES (12 DIVIDERS INCLUDED)					
VC3012DA	30	24	3 7/8	38.0	\$443.00
VC3612DA	36	24	3 7/8	40.0	444.00

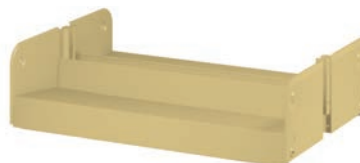

WSB3624A



VC3612DA

Sloping Base Shelves and Video Sloping Base Shelves are sloped at 9°, aiding visually those items displayed on the bottom shelf. Video Sloping Base Shelves are slotted on 1" centers for dividers, with 5" integral backstop; twelve adjustable dividers are provided.

NOTE: MOST PRODUCTS AVAILABLE IN 24"W AT AN UPCHARGE OF 25%.

ADJUSTABLE SHELVES

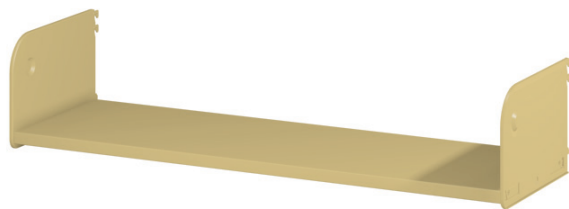

Includes shelf brackets. Can be furnished in additional widths or depths; contact factory for pricing.

CAT. NO.	W	D	H	WT.	PRICE
BL3008A	30	8	13/16	5.9	\$60.00
BL3009A	30	9	13/16	6.6	68.00
BL3010A	30	10	13/16	7.2	69.00
BL3011A	30	11	13/16	7.9	76.00
BL3012A	30	12	13/16	8.6	77.00
BL3013A	30	13	13/16	9.2	95.00
BL3014A	30	14	13/16	9.9	97.00
BL3016A	30	16	13/16	11.2	110.00
BL3608A	36	8	13/16	6.7	60.00
BL3609A	36	9	13/16	7.5	68.00
BL3610A	36	10	13/16	8.2	69.00
BL3611A	36	11	13/16	9.0	76.00
BL3612A	36	12	13/16	9.8	77.00
BL3613A	36	13	13/16	10.5	95.00
BL3614A	36	14	13/16	11.3	97.00
BL3616A	36	16	13/16	12.8	110.00

ADJUSTABLE DIVIDER SHELVES

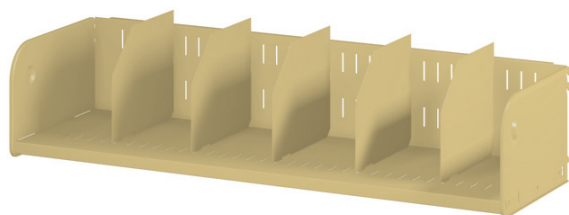

Slotted on 1" centers to accommodate dividers. Includes 5" back, brackets and 5 adjustable dividers per shelf.

CAT. NO.	W	D	H	WT.	PRICE
BDA3010A	30	10	13/16	12.8	\$131.00
BDA3011A	30	11	13/16	13.5	137.00
BDA3012A	30	12	13/16	14.2	141.00
BDA3013A	30	13	13/16	14.8	141.00
BDA3016A	30	16	13/16	17.9	181.00
BDA3610A	36	10	13/16	14.1	131.00
BDA3611A	36	11	13/16	14.9	137.00
BDA3612A	36	12	13/16	15.7	141.00
BDA3613A	36	13	13/16	16.4	149.00
BDA3616A	36	16	13/16	20.0	185.00

SHELF BRACKETS



LEFT BRACKET



RIGHT BRACKET

Attaches shelves to unit uprights. ***NOTE:** Listed catalog numbers are for left bracket only; for right bracket, change the suffix "L" to "R".

CAT. NO.	W	D	H	WT.	PRICE
ASBRK08L*	1/4	8	7 1/2	1.0	\$9.20
ASBRK09L*	1/4	9	7 1/2	1.1	10.20
ASBRK10L*	1/4	10	7 1/2	1.2	10.50
ASBRK11L*	1/4	11	7 1/2	1.4	12.20
ASBRK12L*	1/4	12	7 1/2	1.5	12.70
ASBRK13L*	1/4	13	7 1/2	1.6	14.70
ASBRK14L*	1/4	14	7 1/2	1.8	15.10
ASBRK16L*	1/4	16	7 1/2	2.0	18.10

DIVIDERS

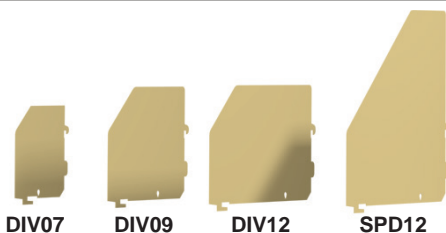

DIV07

DIV09

DIV12

SPD12

CAT. NO.	USE WITH	D	H	WT.	PRICE
DIV07	7" - 9" Shelves	7	6	0.4	\$4.80
DIV09	10" through 13"	9	7 1/2	0.7	6.60
DIV12	14" through 16"	12	7 1/2	1.0	9.20
SPD12	14" through 16"	9	12	1.6	19.30

SHIMS



Used to aid in the leveling of fixed base units. Zinc finish.

CAT. NO.	W	D	H	WT.	PRICE
SHIM	2	2 1/2	1/16	0.1	\$2.10

NOTE: MOST PRODUCTS AVAILABLE IN 24"W AT AN UPCHARGE OF 25%.

HINGED PERIODICAL DISPLAY SHELVES

CAT. NO.	W	D	H	WT.	PRICE
PDS3012A	30	12	14	15.5	\$153.00
PDS3612A	36	12	14	18.0	485.00
PDS3012ACLH*	30	12	14	14.9	185.00
PDS3612ACLH*	36	12	14	18.0	185.00
WITH PLEXIGLASS COVER					
PDSCA30	30	12	14	22.0	\$370.00
PDSCA	36	12	14	23.0	370.00



PERIODICAL DISPLAY SHELF



PERIODICAL DISPLAY SHELF WITH PLEXIGLASS COVER

Sloped for display. 14" high periodical surface.
*Includes continuous label holder.

FIXED SLOPED DISPLAY SHELVES

CAT. NO.	W	D	H	WT.	PRICE
SDS3012A	30	12	12	7.3	\$124.00
SDS3612A	36	12	12	9.6	124.00
SDS3012ACLH*	30	12	12	13.1	209.00
SDS3612ACLH*	36	12	12	9.2	184.00
WITH PLEXIGLASS COVER					
SDSCA30	30	12	12	11.8	\$360.00
SDSCA	36	12	12	11.8	364.00



SLOPED DISPLAY SHELF



SLOPED DISPLAY SHELF WITH PLEXIGLASS COVER

Sloped for display. 12" periodical surface.
*Includes continuous label holder.

INTEGRAL BACK SHELVES

CAT. NO.	W	D	H	WT.	PRICE
BLIB3608A	36	8	13/16	7.5	\$84.00
BLIB3609A	36	9	13/16	8.3	90.00
BLIB3610A	36	10	13/16	9.0	92.00
BLIB3611A	36	11	13/16	9.8	101.00
BLIB3612A	36	12	13/16	10.8	109.00
BLIB3613A	36	13	13/16	11.5	122.00
BLIB3616A	36	16	13/16	13.8	140.00

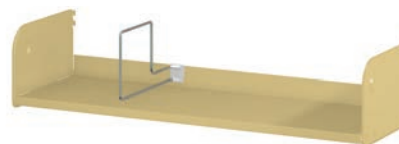

Built-in 2" backstop keeps items organized. Includes brackets and one wire divider per shelf. For 30" shelf, change "BLIB36" to "BLIB30" (e.g. BLIB3016A).

SLOPED INTEGRAL BACK SHELVES

CAT. NO.	W	D	H	WT.	PRICE
SIBS3608A	36	8	13/16	7.4	\$71.00
SIBS3609A	36	9	13/16	8.1	75.00
SIBS3610A	36	10	13/16	8.8	79.00
SIBS3611A	36	11	13/16	9.7	88.00
SIBS3612A	36	12	13/16	10.4	94.00



Shelves have a 7° slope.

Built-in 2" backstop keeps items from falling off sloped shelf. For 30" shelf, change "SIBS36" to "SIBS30" (e.g. SIBS3016A).

MULTIPURPOSE DISPLAY SHELVES

CAT. NO.	TYPE	W	D	H	WT.	PRICE
MP3610A	No Dividers	36	10	8	10.2	\$115.00
MPD3610A	With Dividers	36	10	8	12.4	141.00

Divider shelves come with 6 dividers.



AS SLOPING DISPLAY SHELF



AS INTEGRAL BACK SHELF

Two-positional shelf allows you to have either a sloping display shelf or (reversed) an integral back shelf. Ideal for displaying video tapes, audio cassettes, art books, etc.

MULTIPURPOSE BASE SHELVES

CAT. NO.	TYPE	W	D	H	WT.	PRICE
SINGLE ENTRY						
MPB3610A	No Dividers	36	10	8	15.6	\$191.00
MPDB3610A	With Dividers	36	10	8	17.8	217.00
DOUBLE ENTRY						
MPB3620A	No Dividers	36	20	8	38.0	\$331.00
MPDB3620A	With Dividers	36	20	8	42.0	385.00



SINGLE ENTRY



DOUBLE ENTRY

Two-positional shelf can be used as either a sloping display shelf or (reversed) an integral back shelf. Divider shelves come with 6 dividers.

NOTE: MOST PRODUCTS AVAILABLE IN 24"W AT AN UPCHARGE OF 25%.

STORAGE SHELVES



Used with sloped display shelves (at left on page 16), or any place where a flat shelf is desired. For 30" shelf, change "IN36" to "IN30" (e.g. IN3010A)

CAT. NO.	W	D	H	WT.	PRICE
IN3610A	36	10	13/16	6.9	\$62.00
IN3612A	36	12	13/16	8.1	68.00
IN3613A	36	13	13/16	8.6	80.00
IN3614A	36	14	13/16	9.5	85.00
IN3616A	36	16	13/16	10.5	93.00
IN3618A	36	18	13/16	11.7	108.00
IN3619A	36	19	13/16	12.4	113.00

FACE-OUT DISPLAY SHELF



CAT. NO.	W	D	H	WT.	PRICE
FODSA	36	2 3/4	5 9/16	6.2	\$100.00

Used to display compact discs and DVDs. Shelf has a 7° slope.

VIDEO CASSETTE/ PAPERBACK BOOK SHELF

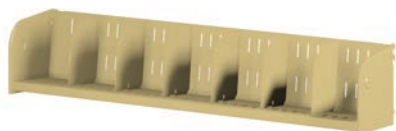

Slopes to allow convenient viewing of spines on paperbacks and video cassettes. Six adjustable dividers included per shelf.

CAT. NO.	W	D	H	WT.	PRICE
VCS3007A	30	6	7 1/2	11.5	\$117.00
VCS3008A	30	7	7 1/2	10.6	124.00
VCS3607A	36	6	7 1/2	10.8	117.00
VCS3608A	36	7	7 1/2	11.5	124.00
DIV07	(DIVIDER ONLY)			0.4	4.80

SLIDING REFERENCE SHELVES*

*Brackets included.



Used with sloped display shelves (at left on page 16), or any place where a flat shelf is desired. For 30" shelf, change "IN36" to "IN30" (e.g. IN3010A)

CAT. NO.	W	D	H	WT.	PRICE
SRS3008A	30	8	3	9.2	\$356.00
SRS3009A	30	9	3	8.2	305.00
SRS3010A	30	10	3	13.1	350.00
SRS3012A	30	12	3	15.6	402.00
SRS3608A	36	8	3	9.2	356.00
SRS3609A	36	9	3	8.2	305.00
SRS3610A	36	10	3	14.0	402.00
SRS3612A	36	12	3	16.6	402.00

ZIG-ZAG SHELF

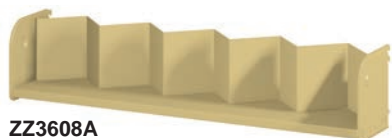

ZZ3608A

Adjustable shelf with paperback insert. Ideal for displaying audio cassette or paperback books.

CAT. NO.	W	D	H	WT.	PRICE
ZZ3008A	30	7	5 13/16	10.1	\$164.00
ZZ3608A	36	7	5 13/16	10.9	160.00
INSERT ONLY					
ZZPD	36	18	5	3.8	\$94.00

2.5" Weld Frame

NOTE: MOST PRODUCTS AVAILABLE IN 24"W AT AN UPCHARGE OF 25%.

CABINETS



CAT. NO.	W	D	H	WT.	PRICE
CABINET					
FDCB36L	36	17 5/8	15 1/2	53.0	\$1,931.00

All welded construction. Ideal for storing valuable items that need to be secured. Includes flipper door and lock with two keys.

MEDIA HANGER RACK



CAT. NO.	W	D	H	WT.	PRICE
HB30A	30	6 1/2	4 1/4	2.1	\$125.00
HB36A	36	6 1/2	4 1/4	2.1	125.00

Consists of brackets with hanger rod for clear-view plastic media bags.

WORK SHELF AND BRACKETS

CAT. NO.	W	D	H	WT.	PRICE
LC54A	36	24	27 1/2	30.0	\$1,431.00
LCL (Legs Only, Per Pair)				3.0	182.00
LCBRK24L (Left Bracket Only)				3.6	183.00
LCBRK24R (Right Bracket Only)				3.6	183.00

24" deep plastic shelf laminate supported by two steel triangular brackets for work surface with shelving range. Must state desired finish of work shelf.

LEGS



WORK SHELF WITH BRACKETS

METAL BROWSING BOX

CAT. NO.	W	D	H	WT.	PRICE
BRB3005A	30	14 1/2	5 1/2	13.5	\$389.00
BRB3605A	36	14 1/2	5 1/2	15.3	618.00
BRBWD (Divider Only)				0.1	13.30

Ideal for storing all media items. Includes 2 wire dividers.



BROWSING BOX

DIVIDER

PULL-OUT BROWSING BOX

CAT. NO.	W	D	H	WT.	PRICE
WITH SLIDING DIVIDER					
XBRB43611A	36	11 1/2	5 1/2	29.0	\$815.00
TXBWD (Divider Only)				0.3	25.00
WITH PLATE-TYPE DIVIDER and 3" FRONT					
XHDBRB3611A	36	11 1/2	5 1/2	31.0	\$951.00
BRBDIVA (Divider Only)				0.4	8.50

A pull out browsing box mounted on full extension ball-bearing suspensions. Ideal for storing all media items. XBRB3611A includes 2 wire dividers; XDBRB3611A includes 4 plate type dividers.



XBRB43611A



XHDBRB3611A

NOTE: MOST PRODUCTS AVAILABLE IN 24"W AT AN UPCHARGE OF 25%.

NEWSPAPER RACK



CAT. NO.	TYPE	W	D	H	WT.	PRICE
NPR6	6 Holders	36	12	14	9.6	\$1,591.00
NPR10	10 Holders	36	12	22	15.2	2,349.00

Displays newspapers. Newspaper sticks included.

WALL HUNG COLUMNS



Slotted strip attaches to wall. Designed to accept all components or accessory items. Special heights available. Hardware not included because of various wall construction.

CAT. NO.	W	D	H	WT.	PRICE
PILWCH24	1 1/2	1	24	2.4	\$73.00
PILWCH30	1 1/2	1	30	2.4	73.00
PILWCH42	1 1/2	1	42	3.1	73.00
PILWCH54	1 1/2	1	54	3.8	78.00
PILWCH60	1 1/2	1	60	3.8	83.00
PILWCH66	1 1/2	1	66	3.8	94.00
PILWCH72	1 1/2	1	72	4.5	85.00
PILWCH78	1 1/2	1	78	4.5	90.00
PILWCH84	1 1/2	1	84	4.8	91.00
PILWCH90	1 1/2	1	90	5.2	94.00

CARD HOLDERS



SCH-B



DCH-B



SCH-CA

For 3" x 5" cards. Used on end panels. Attaches with double-sided tape. Steel holders are finished in black powder coat paint.

CAT. NO.	W	D	H	WT.	PRICE
SINGLE CARD HOLDER					
SCH-B	5 1/4	—	3 1/8	0.1	\$6.50
DOUBLE CARD HOLDER					
DCH-B	10 1/4	—	3 1/8	0.2	\$8.10
ALUMINUM HOLDER					
SCH-CA	5 5/8	—	3 1/2	0.1	\$6.40

TRANSVERSE OVERHEAD TIE BRACING



CAT. NO.	W	D	H	WT.	PRICE
FOR WELD FRAME					
OTBW9	96	2	7/8	5.7	\$56.00

Channel construction top tie furnished in 8 foot lengths. Recommended for added stabilization when bases and shelves are of equal depths.

SHELF LABEL HOLDER



Plastic clip-on holder 5/8" x 5" card. (Paper not included)

CAT. NO.	W	D	H	WT.	PRICE
SLH	5 1/2	2	3 3/4	0.1	\$2.20

WALL CLIP



Used to attach single face units to the wall for support. Wall hardware not included.

CAT. NO.	W	D	H	WT.	PRICE
WCLIP	3	2	1	0.2	\$2.00

RANGE FINDER



For use on end panels or uprights for identification of range contents. Attaches with double-sided tape. Holds two 3" x 5" cards. Finished in black.

CAT. NO.	W	D	H	WT.	PRICE
RFP6	—	6 3/4	3 1/8	0.2	\$9.00

NOTE: MOST PRODUCTS AVAILABLE IN 24"W AT AN UPCHARGE OF 25%.

STEEL BOOK SUPPORTS

CAT. NO.	W	D	H	WT.	PRICE
WITH CORK BACKING					
BSN6	4 9/16	5 1/2	6	0.6	\$11.50
BSN9	4 9/16	5 1/2	9	1.1	14.00
WITH MAGNETIC STRIP					
BSM6	4 9/16	5 1/2	6	1.0	\$11.50
BSM9	4 9/16	5 1/2	9	1.1	14.00

Unattached book support used on surface of shelves. Furnished with cork backing or a magnetic strip, as specified above.



WIRE BOOK SUPPORTS

CAT. NO.	TYPE	W	D	H	WT.	PRICE
WBS6	"V"	3/16	—	6	0.2	\$7.30
WBS9	"V"	3/16	—	9	0.3	8.10
WBSW7	"W"	3/16	—	7	0.3	9.50
WBSW9	"W"	3/16	—	9	0.4	11.20

Heavy spring wire book support. Attaches to underside of shelf. Easily adjustable.



6-INCH "V" SUPPORT



7-INCH "W" SUPPORT



9-INCH "V" SUPPORT



9-INCH "W" SUPPORT

SHELF FILLER

CAT. NO.	W	D	H	WT.	PRICE
SHFIL30	27	2 5/8	1	2.3	\$56.00
SHFIL36	33	2 5/8	1	2.6	54.00

Fills the space between adjustable shelves on double sided units, providing a continuous surface. Attaches with two clips that fasten to underside of shelves.



SLOPED ADJUSTABLE END BRACKET

CAT. NO.	W	D	H	WT.	PRICE
SASBRK08LJ*	1/4	8	7 1/2	1.1	\$11.30
SASBRK09LJ*	1/4	9	7 1/2	1.2	11.30
SASBRK10LJ*	1/4	10	7 1/2	1.3	12.90
SASBRK11LJ*	1/4	11	7 1/2	1.5	14.30
SASBRK12LJ*	1/4	12	7 1/2	1.6	15.00
SASBRK13LJ*	1/4	13	7 1/2	1.7	15.80
SASBRK14LJ*	1/4	14	7 1/2	1.9	23.00

Creates 7 degrees of slope for an adjustable shelf. *NOTE: Listed catalog numbers are for left bracket only; for right bracket, change the suffix "LJ" to "RJ".



LEFT BRACKET



RIGHT BRACKET

NOTE: MOST PRODUCTS AVAILABLE IN 24"W AT AN UPCHARGE OF 25%.

BASE FILLER CLOSURES



CAT. NO.	W	D	H	WT.	PRICE
FOR WELD FRAME					
BFC30	30	2 3/4	1	2.0	\$15.70
BFC36	36	2 3/4	1	1.6	15.70

Use to fill space between uprights when an adjustable base is used.

CAT. NO.	W	D	H	WT.	PRICE
FOR MOBILE CARRIAGE					
BCC30	30	2 1/2	1 3/4	2.1	\$35.00
BCC36	36	2 1/2	1 3/4	2.5	35.00

Use to fill space between uprights when adjustable shelves are used on bottom of unit.

ADJUSTABLE BACKSTOP



CAT. NO.	W	D	H	WT.	PRICE
ABS36	36	7/16	2	1.5	\$25.00

Individual backstop designed to engage in upright slots for adjustability.

REVERSIBLE BACKSTOP – WIRE DIVIDER



CAT. NO.	W	D	H	WT.	PRICE
BACK STOP					
RBS30	30	7/16	2	1.2	\$14.40
RBS36	36	7/16	2	1.3	14.40
WIRE DIVIDER					
BSWBS	—	8 1/2	4	0.2	\$6.30

One side is a regular backstop. The other side is a sliding support backstop (when used with wire divider sold above).

OFFSET CENTER BACKSTOP – LARGE PROFILE



CAT. NO.	W	D	H	WT.	PRICE
CBS30	30	3/8	3 9/32	1.7	\$41.00
CBS36	36	3/8	3 9/32	2.1	41.00

Works as a backstop for each side of a double entry unit, eliminating the need for an individual backstop for each side.

OFFSET CENTER BACKSTOP – SMALL PROFILE



CAT. NO.	W	D	H	WT.	PRICE
CBSS30	30	7/16	2	1.4	\$19.30
CBSS36	36	7/16	2	1.6	19.30

Works as a backstop for each side of a double entry unit, eliminating the need for an individual backstop for each side.

FLOOR ANCHOR

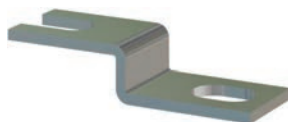

CAT. NO.	W	D	H	WT.	PRICE
FLRANCH3	1	3	5/8	0.1	\$4.80

Used to anchor weld frame units to the floor. For use with weld frame base brackets only. Zinc plated

2.5" Weld Frame

NOTE: MOST PRODUCTS AVAILABLE IN 24"W AT AN UPCHARGE OF 25%.

STEEL CANOPY TOPS

CAT. NO.	W	D	H	WT.	PRICE
SINGLE FACE					
CTS3008	30	8	—	5.4	\$73.00
CTS3009	30	9	—	5.9	76.00
CTS3010	30	10	—	6.4	73.00
CTS3012	30	12	—	7.6	79.00
CTS3013	30	13	—	8.2	98.00
CTS3016	30	16	—	9.7	113.00
CTS3608	36	8	—	6.3	73.00
CTS3609	36	9	—	6.8	76.00
CTS3610	36	10	—	7.4	73.00
CTS3612	36	12	—	8.5	79.00
CTS3613	36	13	—	9.4	96.00
CTS3616	36	16	—	11.6	113.00
DOUBLE FACE					
CTD3016	30	16	—	9.3	\$126.00
CTD3018	30	18	—	10.2	134.00
CTD3020	30	20	—	11.3	125.00
CTD3024	30	24	—	13.5	139.00
CTD3026	30	26	—	14.8	176.00
CTD3032	30	32	—	17.9	214.00
CTD3616	36	16	—	10.8	123.00
CTD3618	36	18	—	11.8	133.00
CTD3620	36	20	—	13.0	125.00
CTD3624	36	24	—	15.6	139.00
CTD3626	36	26	—	16.9	176.00
CTD3632	36	32	—	20.0	223.00
BRACKETS WITH HARDWARE					
CTB08S	—	8	—	1.2	\$22.00
CTB09S	—	9	—	1.3	25.00
CTB10S	—	10	—	1.4	18.80
CTB12S	—	12	—	1.8	21.00
CTB13S	—	13	—	2.0	31.00
CTB16S	—	16	—	2.4	39.00

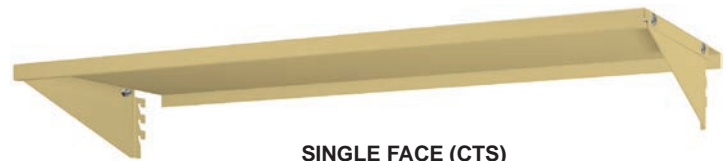

SINGLE FACE (CTS)

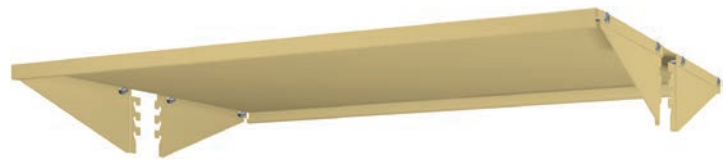

DOUBLE FACE (CTD)



BRACKETS WITH HARDWARE

Keeps dust off your valuable materials. Includes attaching brackets.

*Attaching bracket is also used to secure steel end panels (see page 24). Each pair consists of one left and one right bracket.

CANOPY BRACKETS FOR WOOD TOPS

CAT. NO.	DEPTH	WT.	PRICE
BRACKETS ONLY			
CTIB08S (1 Pair)	8	1.0	\$22.00
CTIB09S (1 Pair)	9	1.1	25.00
CTIB10S (1 Pair)	10	1.2	18.80
CTIB12S (1 Pair)	12	1.6	21.00
CTIB13S (1 Pair)	13	1.8	31.00
CTIB16S (1 Pair)	16	2.2	39.00
CTIB18S (1 Pair)	18	2.6	44.00



BRACKETS ONLY

Used when wood or hard plastic canopy tops are used. For single face units, use 1 pair. For double face units, use 2 pairs. Each pair consists of one left and one right bracket. Wood top and hardware not included.

CANOPY SIGNAGE

CAT. NO.	W	D	H	WT.	PRICE
CPSGN36	35 1/4	—	1 3/4	1.5	\$207.00

Material in aluminum. Cannot be painted.



Easily identify special items or sections with this customizable label holder. Three attachment clips provided.

NOTE: MOST PRODUCTS AVAILABLE IN 24"W AT AN UPCHARGE OF 25%.

FIXED BASE/ADJUSTABLE BASE REINFORCING GUSSETS



GS10-1AL



GS10-1AR



GD10-1A

Used when fixed base shelving units are to be mounted on mobile carriage bases or when additional stabilization is required. Also available for adjustable base shelving units; to order, add "J" to end of catalog number and call factory for pricing and weights (e.g. GS2-16LJA).

CAT. NO.	W	D	H	WT.	PRICE
SINGLE FACE					
GS08-1AL (left)	1/16	8	39 7/8	5.0	\$98.00
GS08-1AR (right)	1/16	8	39 7/8	5.0	98.00
GS09-1AL (left)	1/16	9	39 7/8	5.4	104.00
GS09-1AR (right)	1/16	9	39 7/8	5.4	104.00
GS10-1AL (left)	1/16	10	39 7/8	5.4	107.00
GS10-1AR (right)	1/16	10	39 7/8	5.4	107.00
GS12-1AL (left)	1/16	12	39 7/8	6.2	112.00
GS12-1AR (right)	1/16	12	39 7/8	6.2	112.00
GS13-1AL (left)	1/16	13	39 7/8	9.1	217.00
GS13-1AR (right)	1/16	13	39 7/8	9.1	126.00
GS16-1AL (left)	1/16	16	39 7/8	7.8	141.00
GS16-1AR (right)	1/16	16	39 7/8	7.8	141.00
DOUBLE FACE					
GD08-1A	1/16	16	39 7/8	8.2	\$119.00
GD09-1A	1/16	18	39 7/8	6.6	129.00
GD10-1A	1/16	20	39 7/8	8.8	134.00
GD12-1A	1/16	24	39 7/8	10.1	150.00
GD13-1A	1/16	26	39 7/8	13.6	172.00
GD16-1A	1/16	32	39 7/8	13.9	207.00

MOBILE CARRIAGE REINFORCING GUSSETS



GS10CAL



GS10CAR



GD10CA

Used when adjustable shelves (in lieu of a base shelf and base bracket) are used as a base and are to be mounted on mobile carriage tracks only.

CAT. NO.	W	D	H	WT.	PRICE
SINGLE FACE					
GS08CAL (left)	1/16	8	39 7/8	3.8	\$88.00
GS08CAR (right)	1/16	8	39 7/8	3.8	88.00
GS09CAL (left)	1/16	9	39 7/8	4.3	95.00
GS09CAR (right)	1/16	9	39 7/8	4.3	95.00
GS10CAL (left)	1/16	10	39 7/8	4.5	108.00
GS10CAR (right)	1/16	10	39 7/8	4.5	108.00
GS12CAL (left)	1/16	12	39 7/8	5.1	118.00
GS12CAR (right)	1/16	12	39 7/8	5.1	118.00
GS13CAL (left)	1/16	13	39 7/8	5.8	116.00
GS13CAR (right)	1/16	13	39 7/8	5.8	116.00
GS16CAL (left)	1/16	16	39 7/8	6.4	130.00
GS16CAR (right)	1/16	16	39 7/8	6.4	130.00
DOUBLE FACE					
GD08CA	1/16	16	39 7/8	6.1	\$119.00
GD09CA	1/16	18	39 7/8	7.4	129.00
GD10CA	1/16	20	39 7/8	8.3	140.00
GD12CA	1/16	24	39 7/8	8.7	149.00
GD13CA	1/16	26	39 7/8	10.1	171.00
GD16CA	1/16	32	39 7/8	11.2	191.00

CORNER FILLERS

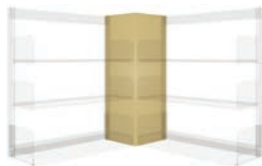

CAT. NO.	HEIGHTS	DEPTHS	WT.	PRICE
SCFhddA	42" to 93"	8" to 32"		CALL FACTORY

Used to make a corner for units placed at right angles to each other. Available in all heights and depths. Specify height and depth (hdd) when ordering.

INTERMEDIATE WALL FILLERS



CAT. NO.	HEIGHTS	DEPTHS	WT.	PRICE
DCFhddA	42" to 93"	8" to 32"		CALL FACTORY

Used to fill a void where two single faced units are joined at a right angle with a double faced unit. Available for all base shelf depths and frame heights. Specify height and depth (hdd) when ordering.

NOTE: MOST PRODUCTS AVAILABLE IN 24"W AT AN UPCHARGE OF 25%.

END PANELS



SINGLE FACE				
CAT. NO.	BASE DEPTH	HEIGHT	WT.	PRICE
WSP4208A	8	42	11.0	\$203.00
WSP4209A	9	42	11.5	209.00
WSP4210A	10	42	12.0	211.00
WSP4212A	12	42	13.1	219.00
WSP4213A	13	42	13.6	221.00
WSP4216A	16	42	15.2	330.00
WSP6608A	8	66	21.0	265.00
WSP6609A	9	66	22.0	272.00
WSP6610A	10	66	23.0	277.00
WSP6612A	12	66	25.0	284.00
WSP6613A	13	66	26.0	284.00
WSP6616A	16	66	28.0	329.00
WSP7808A	8	78	20.0	293.00
WSP7809A	9	78	21.0	301.00
WSP7810A	10	78	22.0	295.00
WSP7812A	12	78	24.0	306.00
WSP7813A	13	78	25.0	310.00
WSP7816A	16	78	28.0	365.00
WSP8408A	8	84	22.0	308.00
WSP8409A	9	84	23.0	318.00
WSP8410A	10	84	24.0	312.00
WSP8412A	12	84	26.0	323.00
WSP8413A	13	84	27.0	336.00
WSP8416A	16	84	30.0	371.00
WSP9008A	8	90	23.0	310.00
WSP9009A	9	90	24.0	332.00
WSP9010A	10	90	25.0	322.00
WSP9012A	12	90	31.0	343.00
WSP9013A	13	90	29.0	537.00
WSP9016A	16	90	32.0	388.00
WSP9308A	8	93	29.0	385.00
WSP9309A	9	93	30.0	393.00
WSP9310A	10	93	31.0	405.00
WSP9312A	12	93	34.0	426.00
WSP9313A	13	93	35.0	437.00
WSP9316A	16	93	39.0	468.00

DOUBLE FACE				
CAT. NO.	BASE DEPTH	HEIGHT	WT.	PRICE
WDP4216A	16	42	14.7	\$407.00
WDP4218A	18	42	15.6	389.00
WDP4220A	20	42	16.8	385.00
WDP4224A	24	42	18.9	429.00
WDP4226A	26	42	20.0	449.00
WDP4232A	32	42	23.0	476.00
WDP6616A	16	66	23.0	477.00
WDP6618A	18	66	24.0	526.00
WDP6620A	20	66	26.0	498.00
WDP6624A	24	66	29.0	537.00
WDP6626A	26	66	31.0	568.00
WDP6632A	32	66	36.0	596.00
WDP7816A	16	78	37.0	525.00
WDP7818A	18	78	29.0	540.00
WDP7820A	20	78	31.0	551.00
WDP7824A	24	78	45.0	571.00
WDP7826A	26	78	36.0	630.00
WDP7832A	32	78	49.0	683.00
WDP8416A	16	84	29.0	553.00
WDP8418A	18	84	31.0	573.00
WDP8420A	20	84	46.0	607.00
WDP8424A	24	84	37.0	606.00
WDP8426A	26	84	39.0	702.00
WDP8432A	32	84	45.0	763.00
WDP9016A	16	90	31.0	570.00
WDP9018A	18	90	33.0	589.00
WDP9020A	20	90	34.0	600.00
WDP9024A	24	90	52.0	631.00
WDP9026A	26	90	42.0	726.00
WDP9032A	32	90	48.0	760.00
WDP9316A	16	93	47.0	601.00
WDP9318A	18	93	50.0	620.00
WDP9320A	20	93	36.0	643.00
WDP9324A	24	93	41.0	721.00
WDP9326A	26	93	60.0	714.00
WDP9332A	32	93	68.0	783.00

Optional attaching brackets available for added stability; see page 22.

STEEL BACKS

CAT. NO.	W	D	H	WT.	PRICE
WNB3042A	30	1	42	17.9	\$291.00
WNB3066A	30	1	66	30.0	455.00
WNB3078A	30	1	78	36.0	524.00
WNB3084A	30	1	84	39.0	541.00
WNB3090A	30	1	90	42.0	569.00
WNB3642A	36	1	42	21.0	291.00
WNB3666A	36	1	66	35.0	455.00
WNB3678A	36	1	78	42.0	524.00
WNB3684A	36	1	84	46.0	541.00
WNB3690A	36	1	90	49.0	569.00

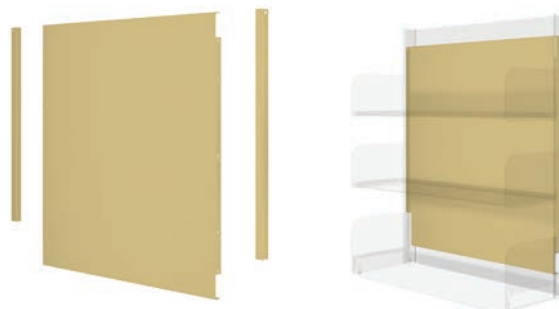

24" wide backs are available at a 25% upcharge. Contact factory for weights.

SINGLE FACE*

*All single face shelving must be wall anchored.
Sway braces not included on single face units.



ED41080S

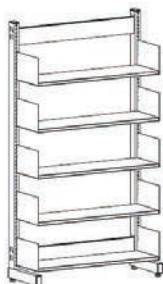

ED61080S

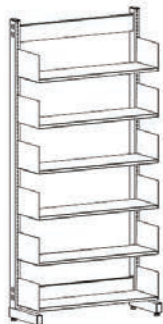

ED71080S

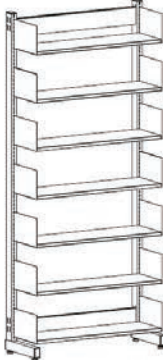

ED81080S

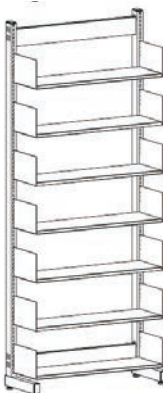

ED91080S

STARTER UNITS			ADDER UNITS			SHELF DEPTH	BASE DEPTH
CAT. NO.	WT.	PRICE	CAT. NO.	WT.	PRICE		
42" HIGH, 3 LEVELS							
ED41080S	53	\$948.00	ED41080A	44	\$662.00	8"	8"
ED41082S	56	958.00	ED41082A	46	676.00	8"	10"
ED41090S	56	1,000.00	ED41090A	46	711.00	9"	9"
ED41091S	57	977.00	ED41091A	47	696.00	9"	10"
ED41100S	59	932.00	ED41100A	49	672.00	10"	10"
ED41102S	61	950.00	ED41102A	50	685.00	10"	12"
ED41120S	63	968.00	ED41120A	52	703.00	12"	12"
66" HIGH, 5 LEVELS							
ED61080S	76	\$1,172.00	ED61080A	62	\$854.00	8"	8"
ED61082S	79	1,204.00	ED61082A	64	871.00	8"	10"
ED61090S	80	1,263.00	ED61090A	66	923.00	9"	9"
ED61091S	81	1,243.00	ED61091A	67	910.00	9"	10"
ED61100S	85	1,201.00	ED61100A	70	874.00	10"	10"
ED61102S	86	1,199.00	ED61102A	72	888.00	10"	12"
ED61120S	90	1,234.00	ED61120A	76	923.00	12"	12"
78" HIGH, 6 LEVELS							
ED71080S	88	\$1,295.00	ED71080A	72	\$951.00	8"	8"
ED71082S	90	1,320.00	ED71082A	74	965.00	8"	10"
ED71090S	93	1,392.00	ED71090A	76	1,028.00	9"	9"
ED71091S	94	1,369.00	ED71091A	77	1,012.00	9"	10"
ED71100S	98	1,302.00	ED71100A	81	974.00	10"	10"
ED71102S	100	1,321.00	ED71102A	83	988.00	10"	12"
ED71120S	105	1,365.00	ED71120A	88	1,032.00	12"	12"
84" HIGH, 7 LEVELS							
ED81080S	97	\$1,394.00	ED81080A	80	\$1,035.00	8"	8"
ED81082S	100	1,414.00	ED81082A	82	1,047.00	8"	10"
ED81090S	103	1,491.00	ED81090A	85	1,117.00	9"	9"
ED81091S	104	1,471.00	ED81091A	86	1,105.00	9"	10"
ED81100S	109	1,402.00	ED81100A	91	1,063.00	10"	10"
ED81102S	110	1,377.00	ED81102A	92	1,055.00	10"	12"
ED81120S	116	1,430.00	ED81120A	98	1,108.00	12"	12"
90" HIGH, 7 LEVELS							
ED91080S	99	\$1,420.00	ED91080A	81	\$1,049.00	8"	8"
ED91082S	102	1,436.00	ED91082A	83	1,058.00	8"	10"
ED91090S	105	1,466.00	ED91090A	86	1,105.00	9"	9"
ED91091S	106	1,494.00	ED91091A	87	1,116.00	9"	10"
ED91100S	111	1,430.00	ED91100A	92	1,077.00	10"	10"
ED91102S	113	1,467.00	ED91102A	93	1,100.00	10"	12"
ED91120S	119	1,520.00	ED91120A	99	1,153.00	12"	12"

30" wide units are available at the price listed. 24" wide units are available at a 25% upcharge. Contact factory for weights.
For 24" units, add "2" to end of catalog number (e.g. ED81080S2); for 30" units, add "3" (e.g. ED81080S3).

DOUBLE FACE



ED42080S

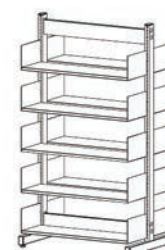

ED62080S

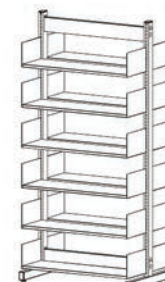

ED72080S

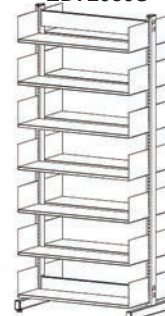

ED82080S

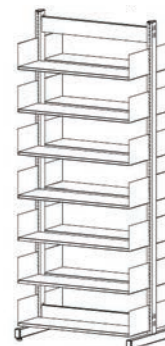

ED92080S

STARTER UNITS			ADDER UNITS			SHELF DEPTH	BASE DEPTH
CAT. NO.	WT.	PRICE	CAT. NO.	WT.	PRICE		
42" HIGH, 3 LEVELS							
ED42080S	77	\$1,205.00	ED42080A	66	\$904.00	8"	16"
ED42082S	81	1,182.00	ED42082A	70	897.00	8"	20"
ED42090S	82	1,238.00	ED42090A	71	951.00	9"	18"
ED42091S	84	1,221.00	ED42091A	73	935.00	9"	20"
ED42100S	87	1,173.00	ED42100A	76	908.00	10"	20"
ED42102S	90	1,207.00	ED42102A	78	934.00	10"	24"
ED42120S	94	1,242.00	ED42120A	82	969.00	12"	24"
66" HIGH, 5 LEVELS							
ED62080S	114	\$1,574.00	ED62080A	99	\$1,232.00	8"	16"
ED62082S	119	1,554.00	ED62082A	103	1,224.00	8"	20"
ED62090S	122	1,651.00	ED62090A	106	1,319.00	9"	18"
ED62091S	124	1,631.00	ED62091A	108	1,301.00	9"	20"
ED62100S	131	1,564.00	ED62100A	115	1,260.00	10"	20"
ED62102S	134	1,596.00	ED62102A	118	1,285.00	10"	24"
ED62120S	142	1,666.00	ED62120A	126	1,355.00	12"	24"
78" HIGH, 6 LEVELS							
ED72080S	133	\$1,768.00	ED72080A	116	\$1,399.00	8"	16"
ED72082S	137	1,737.00	ED72082A	119	1,387.00	8"	20"
ED72090S	142	1,861.00	ED72090A	124	1,504.00	9"	18"
ED72091S	144	1,834.00	ED72091A	126	1,484.00	9"	20"
ED72100S	152	1,767.00	ED72100A	134	1,417.00	10"	20"
ED72102S	155	1,836.00	ED72102A	136	1,483.00	10"	24"
ED72120S	165	1,924.00	ED72120A	146	1,571.00	12"	24"
84" HIGH, 7 LEVELS							
ED82080S	149	\$1,929.00	ED82080A	131	\$1,553.00	8"	16"
ED82082S	154	1,922.00	ED82082A	134	1,550.00	8"	20"
ED82090S	160	2,041.00	ED82090A	141	1,676.00	9"	18"
ED82091S	162	2,038.00	ED82091A	143	1,666.00	9"	20"
ED82100S	172	1,956.00	ED82100A	152	1,586.00	10"	20"
ED82102S	175	1,992.00	ED82102A	155	1,639.00	10"	24"
ED82120S	187	2,098.00	ED82120A	167	1,745.00	12"	24"
90" HIGH, 7 LEVELS							
ED92080S	152	\$1,954.00	ED92080A	132	\$1,565.00	8"	16"
ED92082S	158	1,949.00	ED92082A	137	1,564.00	8"	20"
ED92090S	162	2,064.00	ED92090A	142	1,687.00	9"	18"
ED92091S	166	2,064.00	ED92091A	145	1,679.00	9"	20"
ED92100S	176	1,982.00	ED92100A	155	1,599.00	10"	20"
ED92102S	178	2,014.00	ED92102A	157	1,618.00	10"	24"
ED92120S	190	2,096.00	ED92120A	169	1,707.00	12"	24"

30" wide units are available at the price listed. 24" wide units are available at a 25% upcharge. Contact factory for weights.

For 24" units, add "2" to end of catalog number (e.g. ED82080S2); for 30" units, add "3" (e.g. ED82080S3).

SINGLE FACE*

*All single face shelving must be wall anchored.
Sway braces not included on single face units.



DD41100S

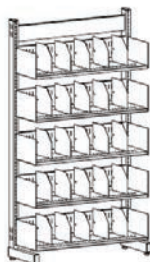

DD61100S

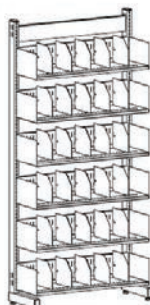

DD71100S

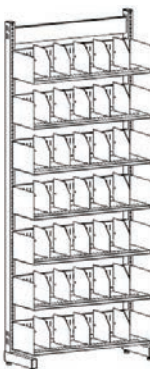

DD91100S

STARTER UNITS			ADDER UNITS			SHELF DEPTH	BASE DEPTH
CAT. NO.	WT.	PRICE	CAT. NO.	WT.	PRICE		
42" HIGH, 3 LEVELS							
DD41100S	75	\$1,236.00	DD41100A	65	\$956.00	10"	10"
DD41102S	77	1,225.00	DD41102A	67	938.00	10"	12"
DD41103S	80	1,252.00	DD41103A	69	962.00	10"	13"
DD41120S	80	1,183.00	DD41120A	70	897.00	12"	12"
DD41130S	82	1,201.00	DD41130A	72	910.00	13"	13"
DD41133S	88	1,266.00	DD41133A	77	977.00	13"	16"
66" HIGH, 5 LEVELS							
DD61100S	112	\$1,670.00	DD61100A	98	\$1,338.00	10"	10"
DD61102S	114	1,659.00	DD61102A	100	1,320.00	10"	12"
DD61103S	117	1,674.00	DD61103A	102	1,338.00	10"	13"
DD61120S	119	1,574.00	DD61120A	105	1,236.00	12"	12"
DD61130S	123	1,588.00	DD61130A	108	1,252.00	13"	13"
DD61133S	128	1,659.00	DD61133A	113	1,320.00	13"	16"
78" HIGH, 6 LEVELS							
DD71100S	131	\$1,880.00	DD71100A	114	\$1,525.00	10"	10"
DD71102S	133	1,869.00	DD71102A	116	1,509.00	10"	12"
DD71103S	135	1,914.00	DD71103A	118	1,539.00	10"	13"
DD71120S	139	1,763.00	DD71120A	122	1,403.00	12"	12"
DD71130S	144	1,807.00	DD71130A	127	1,435.00	13"	13"
DD71133S	149	1,840.00	DD71133A	131	1,485.00	13"	16"
84" HIGH, 7 LEVELS							
DD81100S	147	\$2,068.00	DD81100A	129	\$1,702.00	10"	10"
DD81102S	149	2,010.00	DD81102A	131	1,662.00	10"	12"
DD81103S	152	2,072.00	DD81103A	134	1,702.00	10"	13"
DD81120S	157	1,884.00	DD81120A	139	1,534.00	12"	12"
DD81130S	162	1,949.00	DD81130A	144	1,578.00	13"	13"
DD81133S	167	1,984.00	DD81133A	149	1,631.00	13"	16"
90" HIGH, 7 LEVELS							
DD91100S	149	\$2,090.00	DD91100A	131	\$1,714.00	10"	10"
DD91102S	151	2,097.00	DD91102A	132	1,705.00	10"	12"
DD91103S	154	2,211.00	DD91103A	135	1,771.00	10"	13"
DD91120S	159	1,971.00	DD91120A	140	1,578.00	12"	12"
DD91130S	164	2,086.00	DD91130A	145	1,646.00	13"	13"
DD91133S	170	2,013.00	DD91133A	150	1,645.00	13"	16"

30" wide units are available at the price listed. 24" wide units are available at a 25% upcharge. Contact factory for weights.
For 24" units, add "2" to end of catalog number (e.g. DD81100S2); for 30" units, add "3" (e.g. DD81100S3).

All divider units come with 5 dividers per shelf. Dividers are adjustable on 1" centers.

DOUBLE FACE



DD42100S



DD62100S



DD72100S



DD82100S

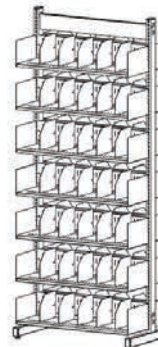

DD92100S

STARTER UNITS			ADDER UNITS			SHELF DEPTH	BASE DEPTH
CAT. NO.	WT.	PRICE	CAT. NO.	WT.	PRICE		
42" HIGH, 3 LEVELS							
DD42100S	120	\$1,739.00	DD42100A	109	\$1,453.00	10"	20"
DD42102S	123	1,714.00	DD42102A	112	1,418.00	10"	24"
DD42103S	128	1,802.00	DD42103A	116	1,480.00	10"	26"
DD42120S	128	1,639.00	DD42120A	117	1,366.00	12"	24"
DD42130S	133	1,700.00	DD42130A	121	1,378.00	13"	26"
DD42133S	142	1,852.00	DD42133A	130	1,525.00	13"	32"
66" HIGH, 5 LEVELS							
DD62100S	186	\$2,486.00	DD62100A	170	\$2,157.00	10"	20"
DD62102S	190	2,460.00	DD62102A	173	2,122.00	10"	24"
DD62103S	195	2,622.00	DD62103A	178	2,220.00	10"	26"
DD62120S	200	2,289.00	DD62120A	184	1,953.00	12"	24"
DD62130S	208	2,447.00	DD62130A	191	2,047.00	13"	26"
DD62133S	218	2,537.00	DD62133A	200	2,162.00	13"	32"
78" HIGH, 6 LEVELS							
DD72100S	218	\$2,857.00	DD72100A	200	\$2,509.00	10"	20"
DD72102S	221	2,864.00	DD72102A	203	2,489.00	10"	24"
DD72103S	226	2,947.00	DD72103A	207	2,547.00	10"	26"
DD72120S	234	2,652.00	DD72120A	216	2,276.00	12"	24"
DD72130S	243	2,736.00	DD72130A	224	2,337.00	13"	26"
DD72133S	251	2,885.00	DD72133A	233	2,482.00	13"	32"
84" HIGH, 7 LEVELS							
DD82100S	249	\$3,230.00	DD82100A	229	\$2,859.00	10"	20"
DD82102S	253	3,200.00	DD82102A	233	2,822.00	10"	24"
DD82103S	258	3,296.00	DD82103A	238	2,887.00	10"	26"
DD82120S	269	2,947.00	DD82120A	249	2,568.00	12"	24"
DD82130S	279	3,048.00	DD82130A	259	2,639.00	13"	26"
DD82133S	289	3,196.00	DD82133A	268	2,783.00	13"	32"
90" HIGH, 7 LEVELS							
DD92100S	253	\$3,255.00	DD92100A	232	\$2,873.00	10"	20"
DD92102S	255	3,223.00	DD92102A	234	2,834.00	10"	24"
DD92103S	260	3,318.00	DD92103A	239	2,898.00	10"	26"
DD92120S	271	3,047.00	DD92120A	250	2,579.00	12"	24"
DD92130S	281	3,070.00	DD92130A	260	2,650.00	13"	26"
DD92133S	291	3,221.00	DD92133A	269	2,797.00	13"	32"

30" wide units are available at the price listed. 24" wide units are available at a 25% upcharge. Contact factory for weights.
For 24" units, add "2" to end of catalog number (e.g. DD82100S2); for 30" units, add "3" (e.g. DD82100S3).

All divider units come with 5 dividers per shelf. Dividers are adjustable on 1" centers.

PERIODICAL DISPLAY UNITS

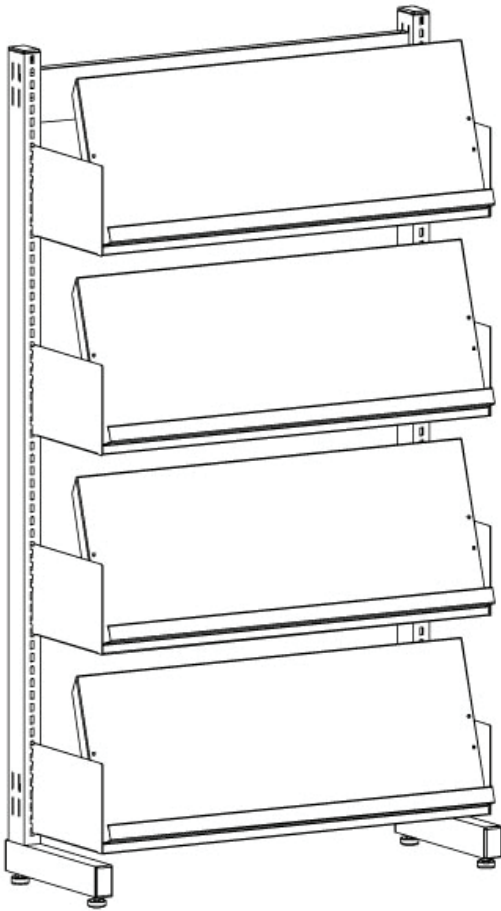

DP61120S

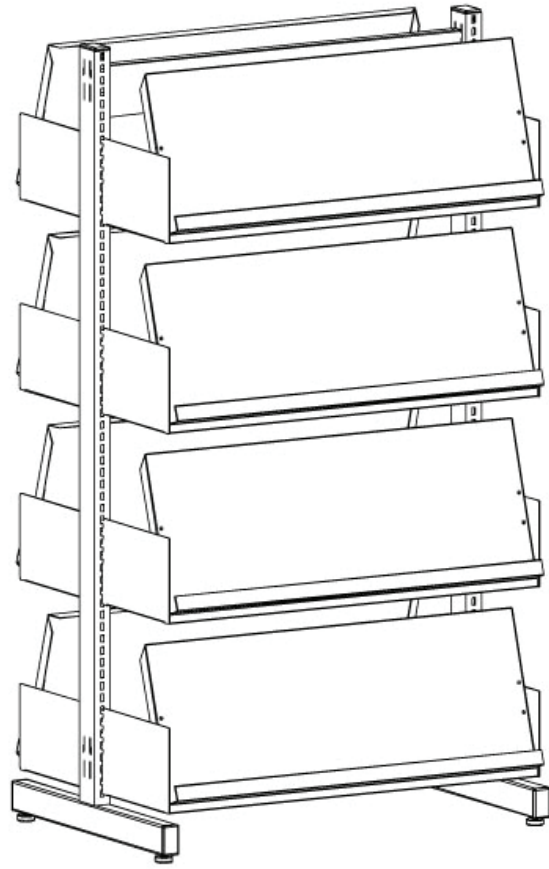

DP62120S

Designer Series

STARTER UNITS			ADDER UNITS			SLOPING SHELVES	STORAGE LEVELS	W	D	
CAT. NO.	WT.	PRICE	CAT. NO.	WT.	PRICE					
SINGLE FACE*										
DP41120S3	80	\$1,509.00	DP41120A3	70	\$1,222.00	3	3	30	12	42
DP61120S3	105	1,863.00	DP61120A3	90	1,525.00	4	4	30	12	66
DP71120S3	125	2,160.00	DP71120A3	109	1,770.00	5	5	30	12	78
DP81120S3	144	2,390.00	DP81120A3	126	2,041.00	6	6	30	12	84
DP91120S3	146	2,477.00	DP91120A3	127	2,085.00	6	6	30	12	90
DP41120S	89	1,509.00	DP41120A	79	1,222.00	3	3	36	12	42
DP61120S	116	1,863.00	DP61120A	101	1,525.00	4	4	36	12	66
DP71120S	139	2,103.00	DP71120A	122	1,770.00	5	5	36	12	78
DP81120S	160	2,390.00	DP81120A	142	2,041.00	6	6	36	12	84
DP91120S	162	2,477.00	DP91120A	143	2,085.00	6	6	36	12	90
DOUBLE FACE										
DP42120S3	130	\$2,278.00	DP42120A3	119	\$1,984.00	6	6	30	24	42
DP62120S3	172	2,869.00	DP62120A3	156	2,533.00	8	8	30	24	66
DP72120S3	207	3,447.00	DP72120A3	189	3,073.00	10	10	30	24	78
DP82120S3	243	3,959.00	DP82120A3	223	3,581.00	12	12	30	24	84
DP92120S3	245	3,982.00	DP92120A3	224	3,592.00	12	12	30	24	90
DP42120S	146	2,278.00	DP42120A	135	1,984.00	6	6	36	24	42
DP62120S	193	2,869.00	DP62120A	177	2,533.00	8	8	36	24	66
DP72120S	233	3,447.00	DP72120A	215	3,073.00	10	10	36	24	78
DP82120S	274	3,959.00	DP82120A	254	3,581.00	12	12	36	24	84
DP92120S**	276	3,982.00	DP92120A**	255	3,592.00	12	12	36	24	90

* All single face shelving must be wall anchored.

** Overhead top bracing recommended.

NOTE: Canopy tops will not fit on 42" high units.

24" units are also available at a 25% upcharge. Contact factory for weights.
For 24" units, add "2" to the end of catalog number (e.g. DP62120S2)

UPRIGHTS

SINGLE ENTRY				DOUBLE ENTRY			
CAT. NO.	WT.	DEPTH	PRICE	CAT. NO.	WT.	DEPTH	PRICE
42" HIGH							
EDSUPT4208	9.3	8"	\$262.00	EDDUPT4208	10.6	16"	\$284.00
EDSUPT4209	9.5	9"	273.00	EDDUPT4209	10.8	18"	269.00
EDSUPT4210	9.7	10"	260.00	EDDUPT4210	11.0	20"	265.00
EDSUPT4211	9.9	11"	274.00	EDDUPT4211	11.1	22"	265.00
EDSUPT4212	10.1	12"	265.00	EDDUPT4212	11.3	24"	273.00
EDSUPT4213	10.2	13"	272.00	EDDUPT4213	11.5	26"	298.00
EDSUPT4216	10.9	16"	272.00	EDDUPT4216	12.1	32"	304.00
66" HIGH							
EDSUPT6608	13.6	8"	\$301.00	EDDUPT6608	14.9	16"	\$319.00
EDSUPT6609	13.8	9"	316.00	EDDUPT6609	15.3	18"	309.00
EDSUPT6610	14.0	10"	307.00	EDDUPT6610	15.6	20"	304.00
EDSUPT6611	14.2	11"	321.00	EDDUPT6611	16.0	22"	312.00
EDSUPT6612	14.4	12"	311.00	EDDUPT6612	16.4	24"	311.00
EDSUPT6613	14.6	13"	314.00	EDDUPT6613	16.8	26"	393.00
EDSUPT6616	15.2	16"	316.00	EDDUPT6616	17.9	32"	351.00
78" HIGH							
EDSUPT7808	15.9	8"	\$321.00	EDDUPT7808	17.2	16"	\$343.00
EDSUPT7809	16.1	9"	336.00	EDDUPT7809	17.4	18"	329.00
EDSUPT7810	16.3	10"	328.00	EDDUPT7810	17.6	20"	323.00
EDSUPT7811	16.5	11"	342.00	EDDUPT7811	17.8	22"	335.00
EDSUPT7812	16.7	12"	333.00	EDDUPT7812	18.0	24"	353.00
EDSUPT7813	16.9	13"	353.00	EDDUPT7813	18.1	26"	370.00
EDSUPT7816	17.5	16"	332.00	EDDUPT7816	18.3	32"	374.00
84" HIGH							
EDSUPT8408	17.0	8"	\$340.00	EDDUPT8408	18.3	16"	\$353.00
EDSUPT8409	17.2	9"	351.00	EDDUPT8409	18.7	18"	344.00
EDSUPT8410	17.4	10"	339.00	EDDUPT8410	18.9	20"	347.00
EDSUPT8411	17.6	11"	353.00	EDDUPT8411	19.1	22"	349.00
EDSUPT8412	17.8	12"	322.00	EDDUPT8412	19.8	24"	353.00
EDSUPT8413	18.0	13"	350.00	EDDUPT8413	20.0	26"	378.00
EDSUPT8416	18.6	16"	333.00	EDDUPT8416	21.0	32"	385.00
90" HIGH							
EDSUPT9008	18.1	8"	\$350.00	EDDUPT9008	19.4	16"	\$365.00
EDSUPT9009	18.3	9"	339.00	EDDUPT9009	19.7	18"	356.00
EDSUPT9010	18.5	10"	353.00	EDDUPT9010	21.0	20"	358.00
EDSUPT9011	18.7	11"	367.00	EDDUPT9011	21.0	22"	354.00
EDSUPT9012	18.9	12"	367.00	EDDUPT9012	21.0	24"	364.00
EDSUPT9013	19.0	13"	413.00	EDDUPT9013	21.0	26"	389.00
EDSUPT9016	19.7	16"	347.00	EDDUPT9016	22.0	32"	398.00

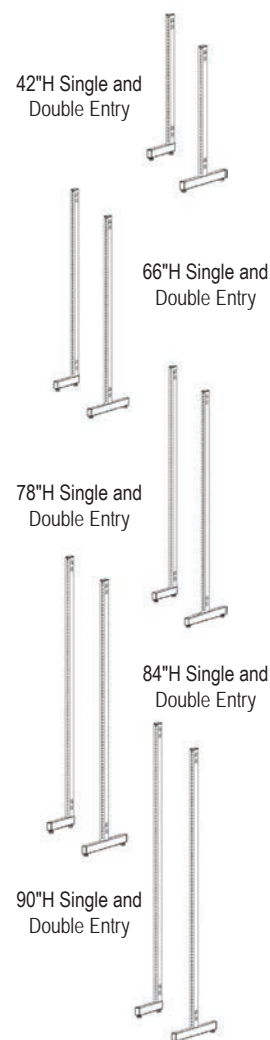

Uprights are sold individually. For seismic application, contact factory.

Designer Series

UPRIGHT EXTENDER

CAT. NO.	W	D	H	WT.	PRICE
DUPEXT18A	—	2 1/2	18	3.7	\$280.00
DUPEXT24A	—	2 1/2	24	4.6	287.00
DUPEXT30A	—	2 1/2	30	5.6	319.00
DUPEXTxxA	—	2 1/2	Varies	Varies	Call Factory

Add to existing frames for more space. Available in a variety of sizes with a 12" minimum. Contact factory for pricing & weights on sizes not shown.



SEISMIC SWAY BRACES

CAT. NO.	DESCRIPTION	W	D	H	WT.	PRICE
SSBR6030A	For 66" and 78" frames	30	1	58	4.5	\$101.00
SSBR7330A	For 84", 90" and 93" frames	30	1	73	5.9	116.00
SSBR6036A	For 66" and 78" frames	36	1	58	4.5	100.00
SSBR7336A	For 84", 90" and 93" frames	36	1	73	5.9	114.00

Provides support for uprights. Sway braces come in pairs and include two tumbuckles with hooklegs.

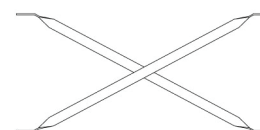

FLOOR ANCHOR

CAT. NO.	W	D	H	WT.	PRICE
DFLRANCH3	1	3	5/8	0.1	\$4.80

Used to aid in the leveling of fixed base units. Zinc finish.

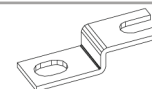

ADJUSTABLE SHELVES

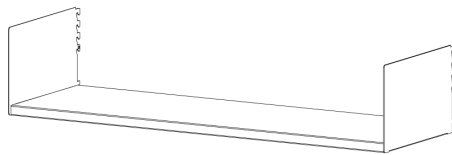

CAT. NO.	W	D	H	WT.	PRICE
ED3008A	30	8	13/16	6.3	\$73.00
ED3009A	30	9	13/16	6.9	76.00
ED3010A	30	10	13/16	7.6	78.00
ED3011A	30	11	13/16	8.4	84.00
ED3012A	30	12	13/16	8.4	87.00
ED3013A	30	13	13/16	9.9	101.00
ED3014A	30	14	13/16	10.5	154.00
ED3016A	30	16	13/16	11.9	213.00

CAT. NO.	W	D	H	WT.	PRICE
ED3608A	36	8	13/16	7.1	\$73.00
ED3609A	36	9	13/16	7.8	83.00
ED3610A	36	10	13/16	8.6	78.00
ED3611A	36	11	13/16	9.5	84.00
ED3612A	36	12	13/16	9.6	87.00
ED3613A	36	13	13/16	11.1	101.00
ED3614A	36	14	13/16	11.8	154.00
ED3616A	36	16	13/16	13.4	215.00

Includes shelf brackets. Can be furnished in additional widths or depths; contact factory for pricing.

ADJUSTABLE DIVIDER SHELVES

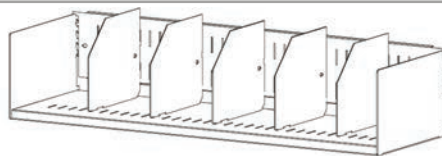

CAT. NO.	W	D	H	WT.	PRICE
DDS3010A	30	10	13/16	12.8	\$168.00
DDS3011A	30	11	13/16	14.4	132.00
DDS3012A	30	12	13/16	14.9	153.00
DDS3013A	30	13	13/16	14.6	157.00
DDS3016A	30	16	13/16	20.0	228.00

CAT. NO.	W	D	H	WT.	PRICE
DDS3610A	36	10	13/16	14.1	\$168.00
DDS3611A	36	11	13/16	15.9	145.00
DDS3612A	36	12	13/16	15.4	153.00
DDS3613A	36	13	13/16	16.1	157.00
DDS3616A	36	16	13/16	20.0	228.00

Slotted on 1" centers to accommodate dividers. Includes 5" back, brackets and 5 dividers per shelf.

DIVIDERS

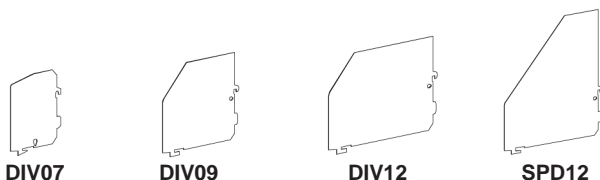

CAT. NO.	USE WITH	D	H	WT.	PRICE
DIV07	7"- 9" Shelves	7	6	0.4	\$4.80
DIV09	10" through 13"	9	7 1/2	0.7	6.60
DIV12	14" through 16"	12	7 1/2	1.0	9.20
SPD12	14" through 16"	9	12	1.6	19.30

SHELF BRACKETS

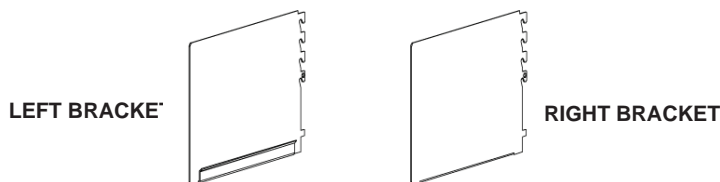

Attaches shelves to unit uprights. *NOTE: Listed catalog numbers are for left bracket only; for right bracket, change the suffix "L" to "R".

CAT. NO.	W	D	H	WT.	PRICE
DSBRK08L*	1/4	8	7 1/2	1.1	\$12.20
DSBRK09L*	1/4	9	7 1/2	1.2	13.20
DSBRK10L*	1/4	10	7 1/2	1.3	11.60
DSBRK11L*	1/4	11	7 1/2	1.5	11.80
DSBRK12L*	1/4	12	7 1/2	1.3	12.50
DSBRK13L*	1/4	13	7 1/2	1.8	15.40
DSBRK14L*	1/4	14	7 1/2	1.9	69.00
DSBRK16L*	1/4	16	7 1/2	2.2	66.00

TOP AND BOTTOM STRUTS



Used to connect two uprights.

CAT. NO.	W	D	H	WT.	PRICE
DSTRUT24	24	1	4 3/8	4.5	\$109.00
DSTRUT30	30	1	4 3/8	6.0	87.00
DSTRUT36	36	1	4 3/8	6.5	87.00

CABINET

CAT. NO.	W	D	H	WT.	PRICE
CABINET					
FDCB36L	36	17 5/8	15 1/2	53.0	\$1,931.00

All welded construction. Ideal for storing valuable items that need to be secured. Includes flipper door and lock with two keys.

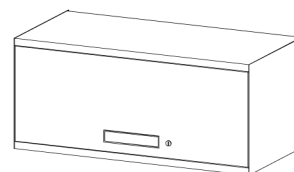

CABINET

MEDIA HANGER RACK

CAT. NO.	W	D	H	WT.	PRICE
HB30A	30	6 1/2	4 1/4	2.1	\$125.00
HB36A	36	6 1/2	4 1/4	2.1	125.00

Consists of brackets with hanger rod for clear-view plastic media bags.



WORK SHELF AND BRACKETS

CAT. NO.	W	D	H	WT.	PRICE
LC54A	36	24	27 1/2	30.0	\$1,431.00
LCL (Legs Only, Per Pair)				3.0	182.00
LCBRK24L (Left Bracket Only)				3.6	183.00
LCBRK24R (Right Bracket Only)				3.6	183.00

24" deep plastic shelf supported by two steel triangular brackets for work surface with shelving range. Must state desired finish of work shelf.

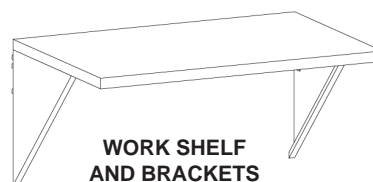

WORK SHELF AND BRACKETS



LEGS

PRINCETON FILE

CAT. NO.	W	D	H	WT.	PRICE
KDPRBOXA	36	16	16	41.0	\$854.00
KDPRBOX1PA	36	16	16	47.0	1,088.00

Displays periodicals while allowing for storage of back issues.

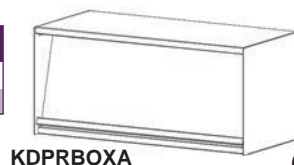

KDPRBOXA



KDPRBOX1PA
(with Plexiglass Front)

NEWSPAPER RACK

CAT. NO.	TYPE	W	D	H	WT.	PRICE
NPR6	6 Holders	36	12	14	9.6	\$1,591.00
NPR10	10 Holders	36	12	22	15.2	2,349.00

Displays newspapers. Newspaper sticks included.

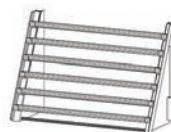

HINGED PERIODICAL DISPLAY SHELVES

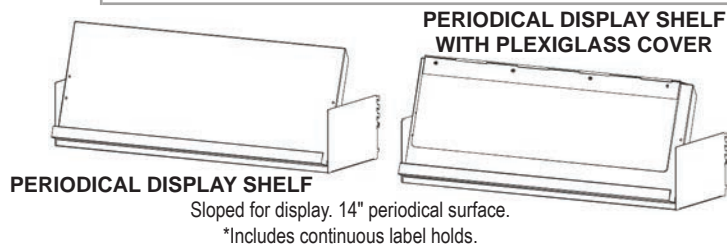

CAT. NO.	W	D	H	WT.	PRICE
DPDS3012A	30	12	14	15.9	\$252.00
DPDS3612A	36	12	14	18.4	252.00
DPDS3012ACLH*	30	12	14	15.3	281.00
DPDS3012ACLH*	36	12	14	18.4	291.00
WITH PLEXIGLASS COVER					
DPDSCA30	30	12	14	22.0	\$468.00
DPDSCA	36	12	14	23.0	468.00

FIXED SLOPED DISPLAY SHELVES

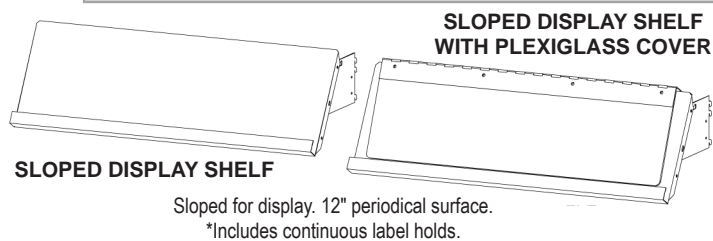

CAT. NO.	W	D	H	WT.	PRICE
SDS3012A	30	12	12	7.3	\$124.00
SDS3612A	36	12	12	9.6	124.00
SDS3012ACLH*	30	12	12	13.1	196.00
SDS3612ACLH*	36	12	12	9.2	184.00
WITH PLEXIGLASS COVER					
SDSCA30	30	12	12	11.8	\$340.00
SDSCA	36	12	12	11.8	364.00

STORAGE SHELVES

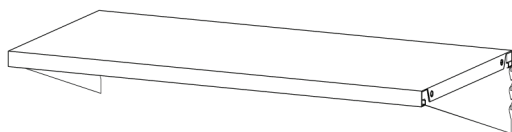

Used with sloped display shelves or any place where a flat shelf is desired.
For 30" shelf, change "DIN36" to "DIN30" (e.g. DIN3010A).

CAT. NO.	W	D	H	WT.	PRICE
DIN3610A	36	10	13/16	7.0	\$115.00
DIN3612A	36	12	13/16	8.2	124.00
DIN3613A	36	13	13/16	8.7	129.00
DIN3614A	36	14	13/16	9.6	132.00
DIN3616A	36	16	13/16	10.6	159.00
DIN3618A	36	18	13/16	11.8	200.00
DIN3619A	36	19	13/16	12.5	202.00

INTEGRAL BACK SHELVES

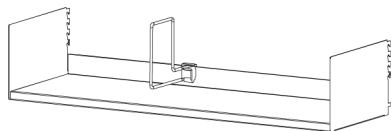

Built-in 2" backstop keeps items organized. Includes brackets and one wire divider per shelf. For 30" shelf, change "DBLIB36" to "DBLIB30" (e.g. DBLIB3016A).

CAT. NO.	W	D	H	WT.	PRICE
DBLIB3608A	36	8	13/16	7.8	\$90.00
DBLIB3609A	36	9	13/16	8.5	96.00
DBLIB3610A	36	10	13/16	9.1	94.00
DBLIB3611A	36	11	13/16	10.1	100.00
DBLIB3612A	36	12	13/16	10.4	109.00
DBLIB3613A	36	13	13/16	11.7	123.00
DBLIB3616A	36	16	13/16	13.9	236.00

METAL BROWSING BOX

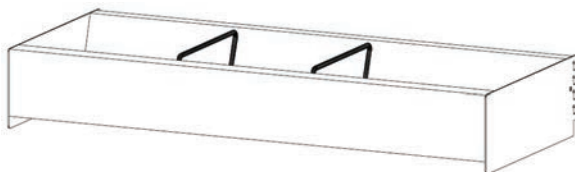

CAT. NO.	W	D	H	WT.	PRICE
HDBRB3611A	30	15 1/16	5 1/2	16.3	\$615.00
HDBRB3614A	36	15 1/16	5 1/2	20.0	670.00
BRBWD (Divider Only)				0.1	13.30

Ideal for storing all media items. Includes 2 wire dividers.

PULL-OUT BROWSING BOX



Ideal for storing all media items in a high capacity environment. Multiple boxes can be placed on top of one another while retaining accessibility to stored items.

CAT. NO.	W	D	H	WT.	PRICE
HDXBRB3611A	30	12	5 1/2	31.1	\$951.00
HDXBRB3614A	36	15 1/16	5 1/2	37.0	984.00

24" and 30" sizes also available; call factory for pricing and weights.

SLIDING REFERENCE SHELVES

CAT. NO.	W	D	H	WT.	PRICE
DSRS3008A	30	8	3	13.7	\$479.00
DSRS3009A	30	9	3	16.0	431.00
DSRS3010A	30	10	3	19.6	561.00
DSRS3012A	30	12	3	23.0	481.00
DSRS3608A	36	8	3	15.1	479.00
DSRS3609A	36	9	3	17.7	502.00
DSRS3610A	36	10	3	13.5	561.00
DSRS3612A	36	12	3	8.0	481.00

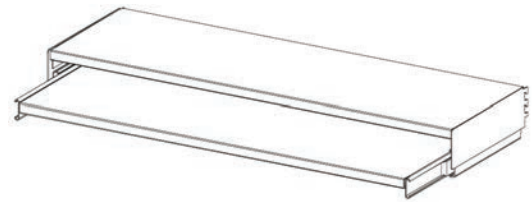

Sturdy full extension slides attach to underside of adjustable shelf. Use two reference shelves for double face units.

ZIG-ZAG SHELF

CAT. NO.	W	D	H	WT.	PRICE
DZZ3008A	30	7	5 13/16	10.4	\$164.00
DZZ3608A	36	7	5 13/16	11.2	166.00
INSERT ONLY					
ZZPD	36	18	5	3.8	\$94.00

Adjustable shelf with paperback insert. Ideal for displaying audio cassette or paperback books.

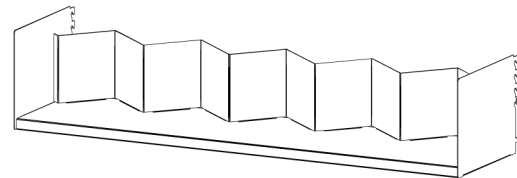

DOUBLE TIER BROWSING BOX

CAT. NO.	W	D	H	WT.	PRICE
DTBRB36A	36	16	8	21.0	\$935.00
WIRE DIVIDER					
DTWD	—	—	—	.2	\$9.40

Two levels of storage for all media items. Holds 168 cassette tapes, 56 VHS videotapes or 156 compact discs

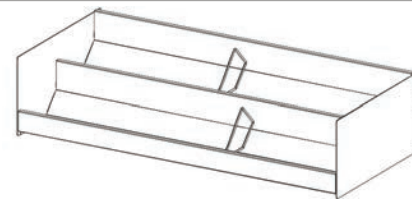

VIDEO CASSETTE/PAPERBACK BOOK SHELF

CAT. NO.	W	D	H	WT.	PRICE
WITH NO SLOTS FOR DIVIDERS					
DVCS3609A	36	9	7 1/2	9.9	\$129.00
DVCS3610A	36	10	7 1/2	10.2	132.00
DVCS3612A	36	12	7 1/2	12.2	149.00
WITH SLOTS AND FIVE DIVIDERS					
DDVCS3609A	36	9	7 1/2	11.9	\$153.00
DDVCS3610A	36	10	7 1/2	12.6	155.00
DDVCS3612A	36	12	7 1/2	15.7	181.00
DIVIDER ONLY					
DIV07	(for 9" deep shelves only)			0.4	\$4.80
DIV09	(for 10" & 12" deep shelves only)			0.7	6.60

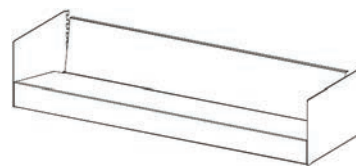

WITH NO DIVIDER SLOTS

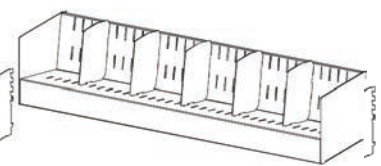

WITH SLOTS AND FIVE DIVIDERS

Slopes to allow convenient viewing of spines on paperback and video cassettes. 30" w size also available; call factory for pricing.

MICROFILM/AUDIO CASSETTE SHELF

CAT. NO.	W	D	H	WT.	PRICE
DSPMF30A	30	10	7 1/2	12.3	\$371.00
DSPMF36A	36	10	7 1/2	12.3	361.00

For storing microfilm or audio cassettes. Capacity: 100 cassettes (36" w shelf).

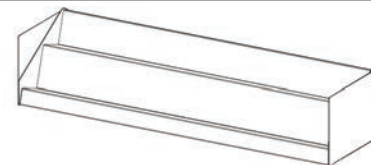

DOUBLE TIER VIDEO CASSETTE SHELF

CAT. NO.	W	D	H	WT.	PRICE
VCDT3014	30	14	12	20.0	\$323.00
VCDT3614	36	14	12	20.0	323.00

Use with compact discs, video cassettes or paperbacks. Sloped; 36" wide shelf holds 60 VHS videotapes or 160 compact discs.

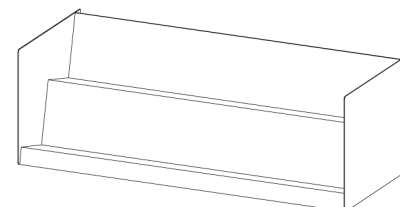

BOOK SUPPORTS

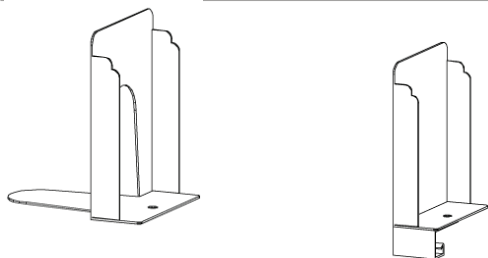

CAT. NO.	W	D	H	WT.	PRICE
WITH CORK BACKING					
BSN6	4 9/16	5 1/2	6	0.6	\$11.50
BSN9	4 9/16	5 1/2	9	1.1	14.00
WITH MAGNETIC STRIP					
BSM6	4 9/16	5 1/2	6	1.0	\$11.50
BSM9	4 9/16	5 1/2	9	1.1	14.00

Unattached book support used on surface of shelves.
Furnished with cork backing or a magnetic strip, as specified above.



CAT. NO.	TYPE	W	D	H	WT.	PRICE
WBS6	"V"	3/16	—	6	0.2	\$7.30
WBS9	"V"	3/16	—	9	0.3	8.10
WBSW7	"W"	3/16	—	7	0.3	9.50
WBSW9	"W"	3/16	—	9	0.4	11.20

Heavy spring wire book support. Attaches to underside of shelf. Easily adjustable.

NOTE: Dividers are shown attached to shelves for clarification purposes only; shelves must be ordered separately

SHELF FILLER

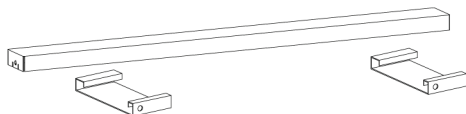

CAT. NO.	W	D	H	WT.	PRICE
SHFIL30	27	2	1	2.3	\$53.00
SHFIL36	33	2	1	2.6	54.00

Fills the space between adjustable shelves on double sided units, providing a continuous surface. Attaches with two clips that fasten to underside of shelves.

REVERSIBLE BACKSTOP – WIRE DIVIDER

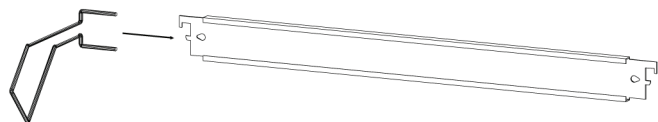

One side is a regular backstop. The other side is a sliding support backstop (when used with wire divider sold above).

CAT. NO.	W	D	H	WT.	PRICE
BACK STOP					
RBS30	30	7/16	2	1.2	\$14.40
RBS36	36	7/16	2	1.3	14.40
WIRE DIVIDER					
BSWBS	—	8 1/2	4	0.2	\$6.30

OFFSET CENTER BACKSTOP – LARGE PROFILE

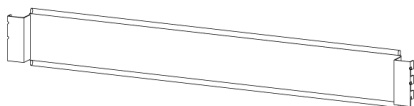

CAT. NO.	W	D	H	WT.	PRICE
CBS30	30	3/8	3 9/32	1.7	\$41.00
CBS36	36	3/8	3 9/32	2.1	41.00

Works as a backstop for each side of a double entry unit, eliminating the need for an individual backstop for each side.

OFFSET CENTER BACKSTOP – SMALL PROFILE

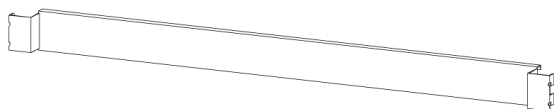

CAT. NO.	W	D	H	WT.	PRICE
CBSS30	30	7/16	2	1.4	\$19.30
CBSS36	36	7/16	2	1.6	19.30

Works as a backstop for each side of a double entry unit, eliminating the need for an individual backstop for each side.

KICK PLATE

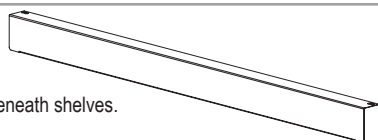

Prevents items from rolling beneath shelves.

CAT. NO.	W	D	H	WT.	PRICE
DKP24A	24	2 1/2	1	0.9	\$37.00
DKP30A	30	2 1/2	1	1.0	30.00
DKP36A	36	2 1/2	1	1.4	30.00

WALL HUNG COLUMNS

CAT. NO.	W	D	H	WT.	PRICE
DPILWCH24	1 1/2	1	24	1.4	\$76.00
DPILWCH30	1 1/2	1	30	1.8	77.00
DPILWCH42	1 1/2	1	42	2.5	81.00
DPILWCH54	1 1/2	1	54	3.2	88.00
DPILWCH60	1 1/2	1	60	3.6	90.00
DPILWCH66	1 1/2	1	66	3.9	92.00
DPILWCH72	1 1/2	1	72	4.3	95.00
DPILWCH78	1 1/2	1	78	4.6	97.00
DPILWCH84	1 1/2	1	84	5.0	99.00
DPILWCH90	1 1/2	1	90	5.3	101.00



Slotted strip attaches to wall. Designed to accept all components or accessory items. Special heights available. Hardware not included because of various wall construction.

CARD HOLDERS

CAT. NO.	W	D	H	WT.	PRICE
SINGLE CARD HOLDER					
SCH-B	5 1/4	—	3 1/8	0.1	\$6.50
DOUBLE CARD HOLDER					
DCH-B	10 1/4	—	3 1/8	0.2	\$8.10
ALUMINUM HOLDER					
SCH-CA	5 5/8	—	3 1/2	0.1	\$6.40



SCH-B

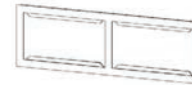

DCH-B



SCH-CA

For 3" x 5" cards. Used on end panels. Attaches with double-sided tape. Steel holders are finished in black powder coat paint.

TRANSVERSE OVERHEAD TOP TIE BRACING

CAT. NO.	W	D	H	WT.	PRICE
OTBW9	96	2	7/8	5.7	\$56.00

Channel construction top tie furnished in 8 foot lengths. Recommended for added stabilization when bases and shelves are of equal depths.



SHELF LABEL HOLDER

CAT. NO.	W	D	H	WT.	PRICE
SLH	5 1/2	2	3 3/4	0.1	\$2.20

Plastic clip-on holder 5/8" x 5" card. (Paper not included)



WALL CLIP

CAT. NO.	W	D	H	WT.	PRICE
WCLIP	3	2	1	0.2	\$2.00

Used to attach single face units to the wall for support. Wall hardware not included.



RANGE FINDER

CAT. NO.	W	D	H	WT.	PRICE
RFP6	—	6 3/4	3 1/8	0.2	\$9.00

For use on end panels or uprights for identification of range contents. Attaches with double-sided tape. Holds two 3" x 5" cards. Finished in black.

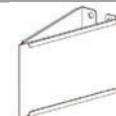

WALL FILLERS

CAT. NO.	HEIGHTS	DEPTHS	WT.	PRICE
CORNER FILLER*				
SCFhddA	42" to 93"	8" to 32"		CALL FACTORY
INTERMEDIATE WALL FILLER**				
DCFhddA	42" to 93"	8" to 32"		CALL FACTORY

*Used to make a corner for units placed at right angles to each other. Available in all heights and depths.

**Used to fill a void where two single faced units are joined at a right angle with a double faced unit. Available for all base shelf depths and frame heights.

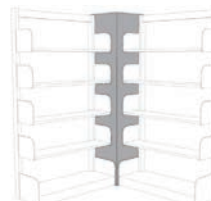

SCFhddA

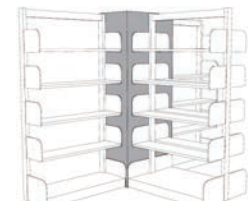

DCFhddA

Specify height and depth (hdd) when ordering.

SINGLE FACE STEEL CANOPY TOPS

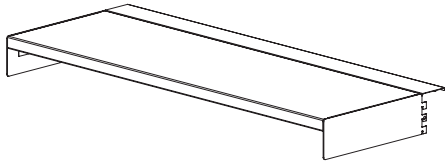

CAT. NO.	W	D	H	WT.	PRICE
SINGLE FACE					
DCTS3008	30	8	—	7.1	\$158.00
DCTS3009	30	9	—	7.5	161.00
DCTS3010	30	10	—	8.0	159.00
DCTS3012	30	12	—	8.8	170.00
DCTS3013	30	13	—	9.5	178.00
DCTS3016	30	16	—	11.3	205.00
DCTS3608	36	8	—	8.2	153.00
DCTS3609	36	9	—	8.7	161.00
DCTS3610	36	10	—	9.3	159.00
DCTS3612	36	12	—	10.3	170.00
DCTS3613	36	13	—	11.0	178.00
DCTS3616	36	16	—	13.1	205.00

DOUBLE FACE STEEL CANOPY TOPS

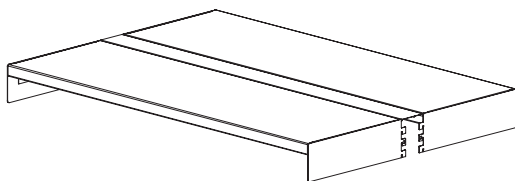

CAT. NO.	W	D	H	WT.	PRICE
DOUBLE FACE					
DCTD3016	30	16	—	13.2	\$266.00
DCTD3018	30	18	—	14.0	277.00
DCTD3020	30	20	—	15.0	272.00
DCTD3024	30	24	—	16.6	294.00
DCTD3026	30	26	—	18.0	310.00
DCTD3032	30	32	—	22.0	344.00
DCTD3616	36	16	—	15.1	266.00
DCTD3618	36	18	—	16.1	276.00
DCTD3620	36	20	—	17.3	272.00
DCTD3624	36	24	—	19.3	294.00
DCTD3626	36	26	—	21.0	310.00
DCTD3632	36	32	—	25.0	364.00

Keeps dust off your valuable materials. Includes attaching brackets.

WOOD TOP CANOPY BRACKETS

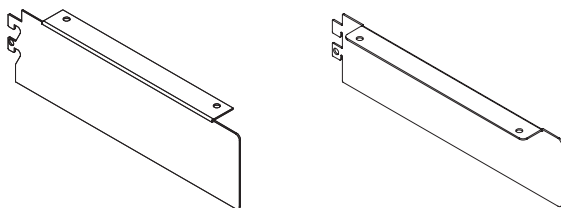

*Attaching bracket is also used to secure steel end panels (see page 16).
Each pair consists of one left and one right bracket.

CAT. NO.	W	D	H	WT.	PRICE
CANOPY BRACKETS FOR WOOD/PLASTIC TOP					
DCTIB08S(1 Pair)	—	8	—	1.2	\$70.00
DCTIB12S(1 Pair)	—	12	—	1.9	86.00

For single face units, use one pair. For double face units, use two pair.

CANOPY SIGNAGE

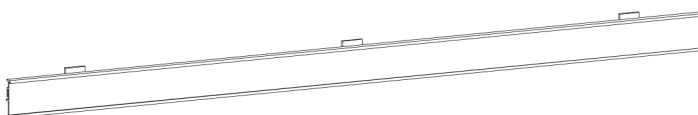

Easily identify special items or sections with this customizable label holder. Three attachment clips provided.

CAT. NO.	W	D	H	WT.	PRICE
CPSGN36	35 1/4	—	1 3/4	1.5	\$195.00

END PANELS



SINGLE FACE

CAT. NO.	BASE DEPTH	HEIGHT	WT.	PRICE
DSP4208LA	8	42	9.2	\$223.00
DSP4209LA	9	42	9.8	227.00
DSP4210LA	10	42	10.4	230.00
DSP4212LA	12	42	11.5	235.00
DSP4213LA	13	42	12.3	249.00
DSP4216LA	16	42	14.4	268.00
DSP6608LA	8	66	13.8	259.00
DSP6609LA	9	66	14.7	267.00
DSP6610LA	10	66	15.7	268.00
DSP6612LA	12	66	18.0	278.00
DSP6613LA	13	66	18.6	298.00
DSP6616LA	16	66	21.0	352.00
DSP7808LA	8	78	16.1	277.00
DSP7809LA	9	78	17.2	286.00
DSP7810LA	10	78	18.3	306.00
DSP7812LA	12	78	21.0	302.00
DSP7813LA	13	78	22.0	322.00
DSP7816LA	16	78	25.0	354.00
DSP8408LA	8	84	17.3	286.00
DSP8409LA	9	84	18.4	302.00
DSP8410LA	10	84	18.4	304.00
DSP8412LA	12	84	22.0	315.00
DSP8413LA	13	84	23.0	323.00
DSP8416LA	16	84	27.0	367.00
DSP9008LA	8	90	18.4	293.00
DSP9009LA	9	90	19.7	304.00
DSP9010LA	10	90	21.0	299.00
DSP9012LA	12	90	24.0	315.00
DSP9013LA	13	90	25.0	346.00
DSP9016LA	16	90	29.0	382.00

DOUBLE FACE

CAT. NO.	BASE DEPTH	HEIGHT	WT.	PRICE
DDP4216A	16	42	16.4	\$340.00
DDP4218A	18	42	17.6	351.00
DDP4220A	20	42	15.9	276.00
DDP4224A	24	42	21.0	307.00
DDP4226A	26	42	21.0	308.00
DDP4232A	32	42	28.0	441.00
DDP6616A	16	66	23.0	396.00
DDP6618A	18	66	25.0	412.00
DDP6620A	20	66	27.0	336.00
DDP6624A	24	66	29.0	393.00
DDP6626A	26	66	32.0	476.00
DDP6632A	32	66	40.0	539.00
DDP7816A	16	78	27.0	423.00
DDP7818A	18	78	29.0	440.00
DDP7820A	20	78	31.0	449.00
DDP7824A	24	78	35.0	393.00
DDP7826A	26	78	38.0	515.00
DDP7832A	32	78	44.0	588.00
DDP8416A	16	84	28.0	435.00
DDP8418A	18	84	31.0	452.00
DDP8420A	20	84	34.0	472.00
DDP8424A	24	84	38.0	508.00
DDP8426A	26	84	40.0	536.00
DDP8432A	32	84	49.0	609.00
DDP9016A	16	90	30.0	448.00
DDP9018A	18	90	33.0	463.00
DDP9020A	20	90	35.0	396.00
DDP9024A	24	90	40.0	426.00
DDP9026A	26	90	43.0	556.00
DDP9032A	32	90	52.0	633.00

*NOTE: Listed catalog numbers are for left panels only; for right panel, change the suffix "LA" to "RA". Additional sizes available; call factory for pricing and weights.

Additional sizes available; call factory for pricing and weights.

STEEL BACKS

CAT. NO.	W	D	H	WT.	PRICE
DNB3042A	30	1	42	12.3	\$258.00
DNB3066A	30	1	66	22.0	337.00
DNB3078A	30	1	78	25.0	392.00
DNB3084A	30	1	84	21.0	410.00
DNB3090A	30	1	90	30.0	447.00
DNB3642A	36	1	42	22.0	240.00
DNB3666A	36	1	66	14.7	337.00
DNB3678A	36	1	78	36.0	392.00
DNB3684A	36	1	84	36.0	410.00
DNB3690A	36	1	90	36.0	413.00

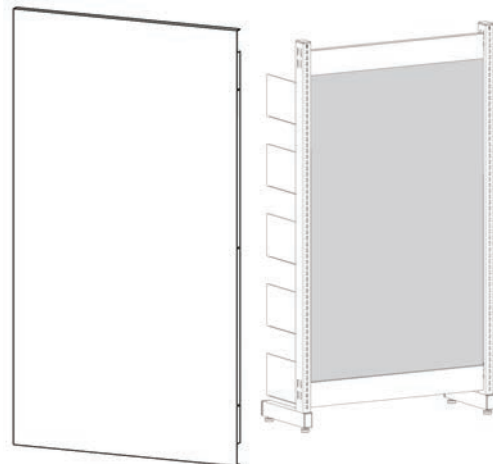

24" wide backs are also available. Please contact factory for pricing and weights.

NOTE: MOST PRODUCTS AVAILABLE IN 24"W AT AN UPCHARGE OF 25%.

THE 2" WELD FRAME SYSTEM

Estey Weld Frame construction eliminates the need for sway bracing and separate starter/adder units.

All Units Feature:

- Upright slot spacing 1" on centers in a 6" repeat pattern for easy shelf alignment.
- Upright posts have 8 right angle bends for added strength.
- Six-point leveling system per double-face section; four-point leveling system per single face section (adjustable levelers provided on both base units).
- Base shelves available in one-piece pan, or in multiple-piece construction with kickplate(see below).
- Electrostatically applied/baked-on powder epoxy/ polyester powder coated finish.

Basic Shelving Components:

- Welded frames
- Base brackets
- Base shelf
- Adjustable shelves and brackets
- Kickplate(s) (black powder coat finish)

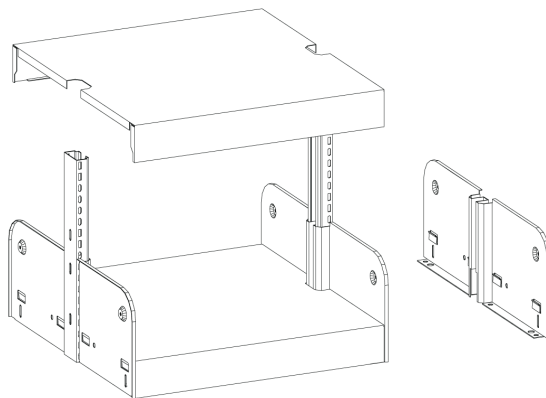

FIXED BASE SHELF

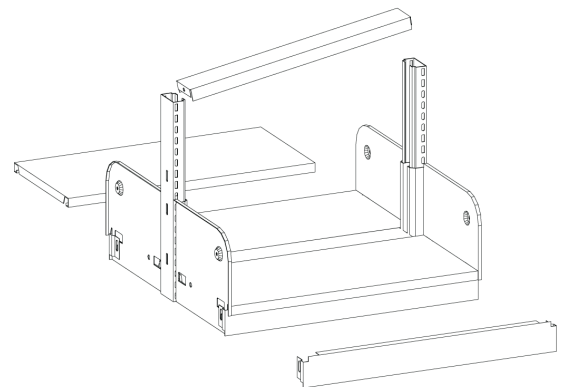

**ADJUSTABLE (KICKPLATE)
BASE SHELF**

NOTE: All shelf depths in this catalog are expressed in nominal sizes. Base shelf dimensions will actually be greater than those shown; all other shelf sizes will be 1" less. Contact factory for specific dimensions.

NOTE: MOST PRODUCTS AVAILABLE IN 24"W AT AN UPCHARGE OF 25%.

PERIODICAL DISPLAY UNITS



W2P61120



W2P62120

2" Weld Frame

CAT. NO.	SLOPING SHELVES	STORAGE LEVELS	W	D	H	WT.	PRICE
SINGLE FACE*							
W2P411203†	3	3	30	12	42	67.0	\$755.00
W2P611203	4	4	30	12	66	87.0	937.00
W2P711203	5	5	30	12	78	106.0	1,109.00
W2P811203	5	5	30	12	84	107.0	1,113.00
W2P911203	6	6	30	12	90	123.0	1,286.00
W2P41120†	3	3	36	12	42	76.0	759.00
W2P61120	4	4	36	12	66	99.0	944.00
W2P71120	5	5	36	12	78	120.0	1,120.00
W2P81120	5	5	36	12	84	121.0	1,113.00
W2P91120	6	6	36	12	90	140.0	1,290.00
DOUBLE FACE							
W2P421203†	6	6	30	24	42	114.0	\$1,197.00
W2P621203	8	8	30	24	66	149.0	1,529.00
W2P721203	10	10	30	24	78	183.0	1,851.00
W2P821203	10	10	30	24	84	215.0	2,156.00
W2P921203**	12	12	30	24	90	216.0	2,167.00
W2P42120†	6	6	36	24	42	130.0	1,197.00
W2P62120	8	8	36	24	66	171.0	1,548.00
W2P72120	10	10	36	24	78	209.0	1,848.00
W2P82120	10	10	36	24	84	246.0	2,180.00
W2P92120**	12	12	36	24	90	248.0	2,167.00

Pivoting periodical shelving with flat storage shelf. With 12" storage shelves & 12" fixed base single face or 24" fixed base double face.

Adjustable base units available. 24" wide units are also available at a 25% upcharge. Contact factory for weights.

† A canopy top will not fit on 42" high units.

*All single face shelving must be wall anchored.

**Overhead top bracing recommended.

NOTE: MOST PRODUCTS AVAILABLE IN 24"W AT AN UPCHARGE OF 25%.

SINGLE FACE*

*All single face shelving must be wall anchored.



W2F41080



W2F61080



W2F71080



W2F81080



W2F91080

FIXED BASE			ADJUSTABLE BASE			SHELF DEPTH	BASE DEPTH
CAT. NO.	WT.	PRICE	CAT. NO.	WT.	PRICE		
42" HIGH, 3 LEVELS							
W2F41080	42	\$475.00	W2A41080	42	\$473.00	8"	8"
W2F41082	44	480.00	W2A41082	44	472.00	8"	10"
W2F41090	44	497.00	W2A41090	45	496.00	9"	9"
W2F41091	46	497.00	W2A41091	46	491.00	9"	10"
W2F41100	47	505.00	W2A41100	47	502.00	10"	10"
W2F41102	48	513.00	W2A41102	49	500.00	10"	12"
W2F41120	51	530.00	W2A41120	52	515.00	12"	12"
66" HIGH, 5 LEVELS							
W2F61080	60	\$620.00	W2A61080	60	\$620.00	8"	8"
W2F61082	62	627.00	W2A61082	62	622.00	8"	10"
W2F61090	64	661.00	W2A61090	64	655.00	9"	9"
W2F61091	65	661.00	W2A61091	65	655.00	9"	10"
W2F61100	68	675.00	W2A61100	68	659.00	10"	10"
W2F61102	69	683.00	W2A61102	70	666.00	10"	12"
W2F61120	75	716.00	W2A61120	76	699.00	12"	12"
78" HIGH, 6 LEVELS							
W2F71080	69	\$697.00	W2A71080	69	\$696.00	8"	8"
W2F71082	71	707.00	W2A71082	71	701.00	8"	10"
W2F71090	73	746.00	W2A71090	74	741.00	9"	9"
W2F71091	75	750.00	W2A71091	75	745.00	9"	10"
W2F71100	79	766.00	W2A71100	79	748.00	10"	10"
W2F71102	80	774.00	W2A71102	80	755.00	10"	12"
W2F71120	88	816.00	W2A71120	88	794.00	12"	12"
84" HIGH, 7 LEVELS							
W2F81080	77	\$759.00	W2A81080	77	\$756.00	8"	8"
W2F81082	79	770.00	W2A81082	79	766.00	8"	10"
W2F81090	82	822.00	W2A81090	83	809.00	9"	9"
W2F81091	83	822.00	W2A81091	84	816.00	9"	10"
W2F81100	88	841.00	W2A81100	88	822.00	10"	10"
W2F81102	89	832.00	W2A81102	90	829.00	10"	12"
W2F81120	98	899.00	W2A81120	99	896.00	12"	12"
90" HIGH, 7 LEVELS							
W2F91080	78	\$792.00	W2A91080	78	\$767.00	8"	8"
W2F91082	80	783.00	W2A91082	80	777.00	8"	10"
W2F91090	84	833.00	W2A91090	84	822.00	9"	9"
W2F91091	85	849.00	W2A91091	85	829.00	9"	10"
W2F91100	90	853.00	W2A91100	90	833.00	10"	10"
W2F91102	91	844.00	W2A91102	91	858.00	10"	12"
W2F91120	100	911.00	W2A91120	100	886.00	12"	12"

30" wide units are available at the price listed. 24" wide units are available at a 25% upcharge. Contact factory for weights.
For 24" units, add "2" to end of catalog number (e.g. W2F810802); for 30" units, add "3" (e.g. W2F810803).

2" Weld Frame

NOTE: MOST PRODUCTS AVAILABLE IN 24"W AT AN UPCHARGE OF 25%.

DOUBLE FACE



W2F42080



W2F62080



W2F72080



W2F82080



W2F92080

FIXED BASE			ADJUSTABLE BASE			SHELF DEPTH	BASE DEPTH
CAT. NO.	WT.	PRICE	CAT. NO.	WT.	PRICE		
42" HIGH, 3 LEVELS							
W2F42080	61	\$623.00	W2A42080	64	\$643.00	8"	16"
W2F42082	65	658.00	W2A42082	68	673.00	8"	20"
W2F42090	66	665.00	W2A42090	69	692.00	9"	18"
W2F42091	68	692.00	W2A42091	71	707.00	9"	20"
W2F42100	71	706.00	W2A42100	74	723.00	10"	20"
W2F42102	74	727.00	W2A42102	78	745.00	10"	24"
W2F42120	80	760.00	W2A42120	83	762.00	12"	24"
66" HIGH, 5 LEVELS							
W2F62080	93	\$878.00	W2A62080	96	\$899.00	8"	16"
W2F62082	96	921.00	W2A62082	99	937.00	8"	20"
W2F62090	100	953.00	W2A62090	103	979.00	9"	18"
W2F62091	102	1,009.00	W2A62091	105	1,004.00	9"	20"
W2F62100	108	1,014.00	W2A62100	112	1,009.00	10"	20"
W2F62102	112	1,035.00	W2A62102	114	1,030.00	10"	24"
W2F62120	124	1,102.00	W2A62120	127	1,093.00	12"	24"
78" HIGH, 6 LEVELS							
W2F72080	108	\$1,011.00	W2A72080	112	\$1,033.00	8"	16"
W2F72082	112	1,058.00	W2A72082	115	1,074.00	8"	20"
W2F72090	118	1,102.00	W2A72090	120	1,128.00	9"	18"
W2F72091	119	1,144.00	W2A72091	123	1,158.00	9"	20"
W2F72100	127	1,151.00	W2A72100	130	1,165.00	10"	20"
W2F72102	130	1,172.00	W2A72102	133	1,186.00	10"	24"
W2F72120	146	1,279.00	W2A72120	149	1,264.00	12"	24"
84" HIGH, 7 LEVELS							
W2F82080	123	\$1,128.00	W2A82080	126	\$1,148.00	8"	16"
W2F82082	113	1,064.00	W2A82082	130	1,194.00	8"	20"
W2F82090	134	1,235.00	W2A82090	136	1,263.00	9"	18"
W2F82091	135	1,281.00	W2A82091	139	1,296.00	9"	20"
W2F82100	145	1,318.00	W2A82100	148	1,305.00	10"	20"
W2F82102	148	1,310.00	W2A82102	151	1,326.00	10"	24"
W2F82120	166	1,404.00	W2A82120	169	1,420.00	12"	24"
90" HIGH, 7 LEVELS							
W2F92080	124	\$1,138.00	W2A92080	127	\$1,159.00	8"	16"
W2F92082	128	1,190.00	W2A92082	131	1,205.00	8"	20"
W2F92090	135	1,301.00	W2A92090	138	1,271.00	9"	18"
W2F92091	137	1,294.00	W2A92091	140	1,309.00	9"	20"
W2F92100	146	1,330.00	W2A92100	151	1,333.00	10"	20"
W2F92102	149	1,322.00	W2A92102	152	1,369.00	10"	24"
W2F92120	168	1,451.00	W2A92120	171	1,431.00	12"	24"

30" wide units are available at the price listed. 24" wide units are available at a 25% upcharge. Contact factory for weights.
For 24" units, add "2" to end of catalog number (e.g. W2F820802); for 30" units, add "3" (e.g. W2F820803).

2" Weld Frame

NOTE: MOST PRODUCTS AVAILABLE IN 24"W AT AN UPCHARGE OF 25%.

SINGLE FACE*

*All single face shelving must be wall anchored.

2" Weld Frame



W2BDF41080



W2BDF61080



W2BDF71080



W2BDF81080



W2BDF91080



W2BDF01080

FIXED BASE			ADJUSTABLE BASE			SHELF DEPTH	BASE DEPTH
CAT. NO.	WT.	PRICE	CAT. NO.	WT.	PRICE		
42" HIGH, 3 LEVELS							
W2BDF41100	63	\$658.00	W2BDA41100	63	\$665.00	10"	10"
W2BDF41102	64	661.00	W2BDA41102	65	673.00	10"	12"
W2BDF41103	65	666.00	W2BDA41103	66	682.00	10"	12"
W2BDF41120	67	691.00	W2BDA41120	68	702.00	12"	12"
W2BDF41130	70	704.00	W2BDA41130	70	714.00	13"	13"
W2BDF41133	79	752.00	W2BDA41133	74	762.00	13"	16"
66" HIGH, 5 LEVELS							
W2BDF61100	96	\$952.00	W2BDA61100	96	\$955.00	10"	10"
W2BDF61102	97	952.00	W2BDA61102	98	963.00	10"	12"
W2BDF61103	98	952.00	W2BDA61103	98	965.00	10"	13"
W2BDF61120	103	1,005.00	W2BDA61120	104	1,002.00	12"	12"
W2BDF61130	107	1,023.00	W2BDA61130	108	1,035.00	13"	13"
W2BDF61133	116	1,077.00	W2BDA61133	111	1,081.00	13"	16"
78" HIGH, 6 LEVELS							
W2BDF71100	112	\$1,105.00	W2BDA71100	113	\$1,107.00	10"	10"
W2BDF71102	113	1,103.00	W2BDA71102	114	1,116.00	10"	12"
W2BDF71103	114	1,112.00	W2BDA71103	115	1,113.00	10"	13"
W2BDF71120	121	1,169.00	W2BDA71120	122	1,163.00	12"	12"
W2BDF71130	126	1,078.00	W2BDA71130	127	1,201.00	13"	13"
W2BDF71133	135	1,089.00	W2BDA71133	130	1,247.00	13"	16"
84" HIGH, 7 LEVELS							
W2BDF81100	127	\$1,226.00	W2BDA81100	128	\$1,242.00	10"	10"
W2BDF81102	129	1,239.00	W2BDA81102	129	1,250.00	10"	12"
W2BDF81103	130	1,229.00	W2BDA81103	130	1,245.00	10"	13"
W2BDF81120	138	1,295.00	W2BDA81120	139	1,306.00	12"	12"
W2BDF81130	143	1,336.00	W2BDA81130	144	1,350.00	13"	13"
W2BDF81133	153	1,396.00	W2BDA81133	148	1,396.00	13"	16"
90" HIGH, 7 LEVELS							
W2BDF91100	129	\$1,239.00	W2BDA91100	130	\$1,253.00	10"	10"
W2BDF91102	130	1,250.00	W2BDA91102	131	1,263.00	10"	12"
W2BDF91103	131	1,240.00	W2BDA91103	132	1,256.00	10"	13"
W2BDF91120	139	1,328.00	W2BDA91120	140	1,319.00	12"	12"
W2BDF91130	145	1,348.00	W2BDA91130	146	1,361.00	13"	13"
W2BDF91133	154	1,407.00	W2BDA91133	149	1,406.00	13"	16"
93" HIGH, 8 LEVELS							
W2BDF01100	144	\$1,484.00	W2BDA01100	144	\$1,498.00	10"	10"
W2BDF01102	145	1,497.00	W2BDA01102	146	1,506.00	10"	12"
W2BDF01103	146	1,488.00	W2BDA01103	146	1,504.00	10"	13"
W2BDF01120	156	1,562.00	W2BDA01120	156	1,575.00	12"	12"
W2BDF01130	162	1,610.00	W2BDA01130	163	1,624.00	13"	13"
W2BDF01133	171	1,670.00	W2BDA01133	175	1,760.00	13"	16"

30" wide units are available at the price listed. 24" wide units are available at a 25% upcharge. Contact factory for weights. For 24" units, add "2" to end of catalog number (e.g. W2BDF811002); for 30" units, add "3" (e.g. W2BDF811003).

All units come with 5 dividers per shelf. Dividers are adjustable on 1" centers.

NOTE: MOST PRODUCTS AVAILABLE IN 24"W AT AN UPCHARGE OF 25%.

DOUBLE FACE

FIXED BASE			ADJUSTABLE BASE			SHELF DEPTH	BASE DEPTH
CAT. NO.	WT.	PRICE	CAT. NO.	WT.	PRICE		
42" HIGH, 3 LEVELS							
W2BDF42100	106	\$1,033.00	W2BDA42100	108	\$1,068.00	10"	20"
W2BDF42102	110	1,061.00	W2BDA42102	111	1,092.00	10"	24"
W2BDF42103	112	1,078.00	W2BDA42103	113	1,095.00	10"	26"
W2BDF42120	116	1,116.00	W2BDA42120	117	1,147.00	12"	24"
W2BDF42130	121	1,147.00	W2BDA42130	122	1,163.00	13"	26"
W2BDF42133	129	1,221.00	W2BDA42133	127	1,218.00	13"	32"
66" HIGH, 5 LEVELS							
W2BDF62100	168	\$1,583.00	W2BDA62100	169	\$1,617.00	10"	20"
W2BDF62102	171	1,610.00	W2BDA62102	172	1,641.00	10"	24"
W2BDF62103	173	1,628.00	W2BDA62103	174	1,630.00	10"	26"
W2BDF62120	183	1,715.00	W2BDA62120	184	1,718.00	12"	24"
W2BDF62130	191	1,763.00	W2BDA62130	192	1,770.00	13"	26"
W2BDF62133	199	1,827.00	W2BDA62133	206	1,912.00	13"	32"
78" HIGH, 6 LEVELS							
W2BDF72100	198	\$1,865.00	W2BDA72100	200	\$1,897.00	10"	20"
W2BDF72102	202	1,893.00	W2BDA72102	203	1,922.00	10"	24"
W2BDF72103	203	1,933.00	W2BDA72103	205	1,903.00	10"	26"
W2BDF72120	217	2,020.00	W2BDA72120	218	2,017.00	12"	24"
W2BDF72130	226	1,831.00	W2BDA72130	228	2,078.00	13"	26"
W2BDF72133	235	1,858.00	W2BDA72133	236	2,164.00	13"	32"
84" HIGH, 7 LEVELS							
W2BDF82100	228	\$2,128.00	W2BDA82100	229	\$2,163.00	10"	20"
W2BDF82102	231	2,156.00	W2BDA82102	232	2,187.00	10"	24"
W2BDF82103	233	2,173.00	W2BDA82103	234	2,160.00	10"	26"
W2BDF82120	249	2,269.00	W2BDA82120	249	2,283.00	12"	24"
W2BDF82130	260	2,374.00	W2BDA82130	262	2,369.00	13"	26"
W2BDF82133	268	2,429.00	W2BDA82133	270	2,456.00	13"	32"
90" HIGH, 7 LEVELS							
W2BDF92100	229	\$2,141.00	W2BDA92100	231	\$2,174.00	10"	20"
W2BDF92102	232	2,167.00	W2BDA92102	233	2,198.00	10"	24"
W2BDF92103	234	2,184.00	W2BDA92103	235	2,173.00	10"	26"
W2BDF92120	251	2,282.00	W2BDA92120	252	2,313.00	12"	24"
W2BDF92130	262	2,386.00	W2BDA92130	263	2,381.00	13"	26"
W2BDF92133	270	2,439.00	W2BDA92133	271	2,468.00	13"	32"
93" HIGH, 8 LEVELS							
W2BDF02100	258	\$2,514.00	W2BDA02100	259	\$2,548.00	10"	20"
W2BDF02102	261	2,541.00	W2BDA02102	262	2,572.00	10"	24"
W2BDF02103	263	2,559.00	W2BDA02103	264	2,545.00	10"	26"
W2BDF02120	283	2,677.00	W2BDA02120	284	2,705.00	12"	24"
W2BDF02130	291	2,724.00	W2BDA02130	296	2,787.00	13"	26"
W2BDF02133	303	2,848.00	W2BDA02133	304	2,874.00	13"	32"

30" wide units are available at the price listed. 24" wide units are available at a 25% upcharge. Contact factory for weights. For 24" units, add "2" to end of catalog number (e.g. W2BDF821002); for 30" units, add "3" (e.g. W2BDF821003).

All units come with 5 dividers per shelf. Dividers are adjustable on 1" centers.



W2BDF42080



W2BDF62080

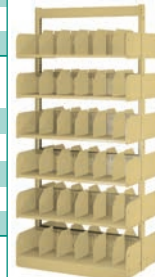

W2BDF72080



W2BDF82080



W2BDF92080



W2BDF102080

2" Weld Frame

NOTE: MOST PRODUCTS AVAILABLE IN 24"W AT AN UPCHARGE OF 25%.

SINGLE FACE*

*All single face shelving must be wall anchored.

2" Weld Frame



W2FIB41080

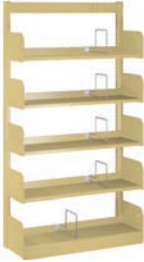

W2FIB61080

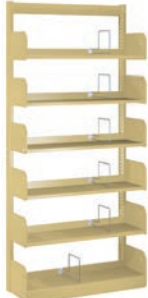

W2FIB71080



W2FIB81080



W2FIB91080

FIXED BASE			ADJUSTABLE BASE			SHELF DEPTH	BASE DEPTH
CAT. NO.	WT.	PRICE	CAT. NO.	WT.	PRICE		
42" HIGH, 3 LEVELS							
W2FIB41080	43	\$545.00	W2AIB41080	43	\$545.00	8"	8"
W2FIB41082	45	538.00	W2AIB41082	45	536.00	8"	10"
W2FIB41090	45	546.00	W2AIB41090	46	560.00	9"	9"
W2FIB41091	46	549.00	W2AIB41091	47	546.00	9"	10"
W2FIB41100	48	553.00	W2AIB41100	48	552.00	10"	10"
W2FIB41102	49	566.00	W2AIB41102	50	568.00	10"	12"
W2FIB41120	52	601.00	W2AIB41120	53	603.00	12"	12"
66" HIGH, 5 LEVELS							
W2FIB61080	62	\$745.00	W2AIB61080	62	\$750.00	8"	8"
W2FIB61082	64	738.00	W2AIB61082	65	738.00	8"	10"
W2FIB61090	66	756.00	W2AIB61090	67	777.00	9"	9"
W2FIB61091	67	762.00	W2AIB61091	68	759.00	9"	10"
W2FIB61100	70	769.00	W2AIB61100	71	769.00	10"	10"
W2FIB61102	72	781.00	W2AIB61102	72	784.00	10"	12"
W2FIB61120	78	851.00	W2AIB61120	79	855.00	12"	12"
78" HIGH, 6 LEVELS							
W2FIB71080	72	\$853.00	W2AIB71080	72	\$860.00	8"	8"
W2FIB71082	74	846.00	W2AIB71082	75	846.00	8"	10"
W2FIB71090	77	869.00	W2AIB71090	78	890.00	9"	9"
W2FIB71091	78	871.00	W2AIB71091	78	871.00	9"	10"
W2FIB71100	82	882.00	W2AIB71100	82	882.00	10"	10"
W2FIB71102	83	895.00	W2AIB71102	84	899.00	10"	12"
W2FIB71120	92	982.00	W2AIB71120	93	986.00	12"	12"
84" HIGH, 7 LEVELS							
W2FIB81080	81	\$941.00	W2AIB81080	81	\$948.00	8"	8"
W2FIB81082	83	934.00	W2AIB81082	83	934.00	8"	10"
W2FIB81090	86	963.00	W2AIB81090	87	984.00	9"	9"
W2FIB81091	87	970.00	W2AIB81091	88	965.00	9"	10"
W2FIB81100	92	979.00	W2AIB81100	92	979.00	10"	10"
W2FIB81102	93	993.00	W2AIB81102	94	995.00	10"	12"
W2FIB81120	104	1,097.00	W2AIB81120	104	1,101.00	12"	12"
90" HIGH, 7 LEVELS							
W2FIB91080	82	\$953.00	W2AIB91080	83	\$962.00	8"	8"
W2FIB91082	84	946.00	W2AIB91082	85	946.00	8"	10"
W2FIB91090	87	976.00	W2AIB91090	89	995.00	9"	9"
W2FIB91091	88	977.00	W2AIB91091	89	977.00	9"	10"
W2FIB91100	93	991.00	W2AIB91100	94	991.00	10"	10"
W2FIB91102	95	1,004.00	W2AIB91102	95	1,008.00	10"	12"
W2FIB91120	105	1,109.00	W2AIB91120	106	1,110.00	12"	12"

Units come with one wire divider per shelf level.

30" wide units are available at the price listed. 24" wide units are available at a 25% upcharge. Contact factory for weights.

For 24" units, add "2" to end of catalog number (e.g. W2FIB810802); for 30" units, add "3" (e.g. W2FIB810803).

CAT. NO.	W	D	H	WT.	PRICE
EXTRA DIVIDERS					
EWD-1	3/16	8	6 1/2	0.4	\$17.50
EWD-2	3/16	12	6 1/2	0.6	19.60

NOTE: MOST PRODUCTS AVAILABLE IN 24"W AT AN UPCHARGE OF 25%.

DOUBLE FACE

FIXED BASE			ADJUSTABLE BASE			SHELF DEPTH	BASE DEPTH
CAT. NO.	WT.	PRICE	CAT. NO.	WT.	PRICE		
42" HIGH, 3 LEVELS							
W2FIB42080	66	\$837.00	W2AIB42080	68	\$805.00	8"	16"
W2FIB42082	70	809.00	W2AIB42082	71	813.00	8"	20"
W2FIB42090	71	823.00	W2AIB42090	72	839.00	9"	18"
W2FIB42091	73	830.00	W2AIB42091	74	833.00	9"	20"
W2FIB42100	76	841.00	W2AIB42100	77	844.00	10"	20"
W2FIB42102	80	869.00	W2AIB42102	81	882.00	10"	24"
W2FIB42120	87	939.00	W2AIB42120	88	949.00	12"	24"
66" HIGH, 5 LEVELS							
W2FIB62080	101	\$1,212.00	W2AIB62080	102	\$1,180.00	8"	16"
W2FIB62082	104	1,180.00	W2AIB62082	106	1,183.00	8"	20"
W2FIB62090	109	1,214.00	W2AIB62090	110	1,235.00	9"	18"
W2FIB62091	110	1,226.00	W2AIB62091	112	1,225.00	9"	20"
W2FIB62100	117	1,239.00	W2AIB62100	118	1,240.00	10"	20"
W2FIB62102	120	1,267.00	W2AIB62102	121	1,282.00	10"	24"
W2FIB62120	134	1,407.00	W2AIB62120	135	1,421.00	12"	24"
78" HIGH, 6 LEVELS							
W2FIB72080	118	\$1,404.00	W2AIB72080	120	\$1,373.00	8"	16"
W2FIB72082	122	1,372.00	W2AIB72082	124	1,373.00	8"	20"
W2FIB72090	128	1,415.00	W2AIB72090	129	1,439.00	9"	18"
W2FIB72091	129	1,422.00	W2AIB72091	131	1,424.00	9"	20"
W2FIB72100	137	1,446.00	W2AIB72100	139	1,449.00	10"	20"
W2FIB72102	141	1,476.00	W2AIB72102	142	1,488.00	10"	24"
W2FIB72120	158	1,646.00	W2AIB72120	159	1,661.00	12"	24"
84" HIGH, 7 LEVELS							
W2FIB82080	135	\$1,581.00	W2AIB82080	136	\$1,550.00	8"	16"
W2FIB82082	138	1,546.00	W2AIB82082	140	1,547.00	8"	20"
W2FIB82090	145	1,600.00	W2AIB82090	146	1,628.00	9"	18"
W2FIB82091	147	1,613.00	W2AIB82091	149	1,609.00	9"	20"
W2FIB82100	156	1,633.00	W2AIB82100	158	1,638.00	10"	20"
W2FIB82102	160	1,661.00	W2AIB82102	161	1,677.00	10"	24"
W2FIB82120	181	1,869.00	W2AIB82120	182	1,885.00	12"	24"
90" HIGH, 7 LEVELS							
W2FIB92080	136	\$1,590.00	W2AIB92080	137	\$1,560.00	8"	16"
W2FIB92082	139	1,558.00	W2AIB92082	141	1,560.00	8"	20"
W2FIB92090	147	1,613.00	W2AIB92090	148	1,638.00	9"	18"
W2FIB92091	149	1,620.00	W2AIB92091	150	1,621.00	9"	20"
W2FIB92100	158	1,646.00	W2AIB92100	159	1,651.00	10"	20"
W2FIB92102	161	1,673.00	W2AIB92102	162	1,690.00	10"	24"
W2FIB92120	182	1,883.00	W2AIB92120	183	1,894.00	12"	24"

Units come with one wire divider per shelf level.

30" wide units are available at the price listed. 24" wide units are available at a 25% upcharge. Contact factory for weights.

For 24" units, add "2" to end of catalog number (e.g. W2FIB8208002); for 30" units, add "3" (e.g. W2FIB8208003).

CAT. NO.	W	D	H	WT.	PRICE
EXTRA DIVIDERS					
EWD-1	3/16	8	6 1/2	0.4	\$17.50
EWD-2	3/16	12	6 1/2	0.6	19.60



W2FIB42080



W2FIB62080



W2FIB72080



W2FIB82080



W2FIB92080

2" Weld Frame

NOTE: MOST PRODUCTS AVAILABLE IN 24"W AT AN UPCHARGE OF 25%.

WELDED FRAMES



WELDED FRAMES



SEISMIC SWAY BRACES

CAT. NO.	DESCRIPTION	W	D	H	WT.	PRICE
W2-4230		30	2	42	15.0	\$188.00
W2-5430		30	2	54	17.0	225.00
W2-6630		30	2	66	19.0	220.00
W2-7830		30	2	78	22.0	242.00
W2-8430		30	2	84	23.0	248.00
W2-9030		30	2	90	24.0	260.00
W2-9330		30	2	93	25.0	377.00
W2-4236		36	2	42	16.0	188.00
W2-5436		36	2	54	18.0	225.00
W2-6636		36	2	66	20.5	220.00
W2-7836		36	2	78	23.0	242.00
W2-8436		36	2	84	24.0	248.00
W2-9036		36	2	90	25.5	260.00
W2-9336		36	2	93	26.0	377.00
W2-10836		36	2	108	29.0	389.00
W2-11236		36	2	112	30.0	431.00
SEISMIC SWAY BRACES						
SSBR6030A	For 66" and 78" frames	30	1	58	4.5	\$108.00
SSBR7330A	For 84", 90" and 93" frames	30	1	73	5.9	123.00
SSBR6036A	For 66" and 78" frames	36	1	58	4.5	100.00
SSBR7336A	For 84", 90" and 93" frames	36	1	73	5.9	114.00

Special widths or heights are available. Contact factory for pricing.

SEISMIC WELDED FRAMES



Eliminates the need for sway braces.

CAT. NO.	W	D	H	WT.	PRICE
SW2-7830	30	2	78	30.0	\$388.00
SW2-8430	30	2	84	31.0	392.00
SW2-9030	30	2	90	32.0	392.00
SW2-7836	36	2	78	32.0	388.00
SW2-8436	36	2	84	33.0	392.00
SW2-9036	36	2	90	35.0	392.00

WELDED FRAME EXTENDER



Add to existing frames for more space. Available in a variety of sizes with a 12" minimum. Contact factory for pricing and weights on sizes not shown.

CAT. NO.	W	D	H	WT.	PRICE
WFEXT2-3618	36	2	18	9.2	\$238.00
WFEXT2-3624	36	2	24	11.2	241.00
WFEXT2-3630	36	2	30	13.9	266.00
WFEXT2-36xx	36	2	Varies	Varies	Contact Factory

NOTE: MOST PRODUCTS AVAILABLE IN 24"W AT AN UPCHARGE OF 25%.

CLOSED BASE SHELVES - SINGLE FACE

CAT. NO.	W	D	H	WT.	PRICE
FOR FIXED BASE SHELVES					
WB2-3608A	36	8	3 5/16	12.3	\$165.00
WB2-3609A	36	9	3 5/16	13.0	172.00
WB2-3610A	36	10	3 5/16	14.3	175.00
WB2-3612A	36	12	3 5/16	15.5	183.00
WB2-3613A	36	13	3 5/16	16.4	207.00
WB2-3616A	36	16	3 5/16	24.0	227.00
FOR ADJUSTABLE BASE SHELVES					
WA2-3608A	36	8	3 5/16	12.2	\$165.00
WA2-3609A	36	9	3 5/16	13.7	174.00
WA2-3610A	36	10	3 5/16	14.4	173.00
WA2-3612A	36	12	3 5/16	15.8	182.00
WA2-3613A	36	13	3 5/16	16.7	203.00
WA2-3616A	36	16	3 5/16	18.8	223.00



Comes complete with base brackets. Kickplates for adjustable base shelves are furnished with black powder coat finish. If 30" shelves are desired, change the number "36" to "30" (e.g. WA2-3013A or WB2-3013A). Call factory for weights on 30" shelves.

CLOSED BASE SHELVES - DOUBLE FACE

CAT. NO.	W	D	H	WT.	PRICE
FOR FIXED BASE SHELVES					
WB2-3616DA	36	16	3 5/16	18.2	\$207.00
WB2-3618A	36	18	3 5/16	19.8	218.00
WB2-3620A	36	20	3 5/16	22.0	241.00
WB2-3624A	36	24	3 5/16	25.0	262.00
WB2-3626A	36	26	3 5/16	27.0	295.00
WB2-3632A	36	32	3 5/16	32.0	351.00
FOR ADJUSTABLE BASE SHELVES					
WA2-3616DA	36	16	3 5/16	21.0	\$228.00
WA2-3618A	36	18	3 5/16	23.0	246.00
WA2-3620A	36	20	3 5/16	25.0	255.00
WA2-3624A	36	24	3 5/16	28.0	281.00
WA2-3626A	36	26	3 5/16	30.0	309.00
WA2-3632A	36	32	3 5/16	35.0	323.00



Comes complete with base brackets. Kickplates for adjustable base shelves are furnished with black powder coat finish. If 30" shelves are desired, change the number "36" to "30" (e.g. WA2-3013A or WB2-3013A). Call factory for weights on 30" shelves.

CLOSED BASE SHELVES WITH INTEGRAL BACK AND DIVIDERS - SINGLE FACE

CAT. NO.	W	D	H	WT.	PRICE
FOR FIXED BASE SHELVES					
TBDF2-3610	36	10	3 5/16	18.3	\$204.00
TBDF2-3612	36	12	3 5/16	19.5	217.00
TBDF2-3613	36	13	3 5/16	20.0	244.00
TBDF2-3616	36	16	3 5/16	25.0	269.00
FOR ADJUSTABLE BASE SHELVES					
TBDA2-3610	36	10	3 5/16	18.9	\$217.00
TBDA2-3612	36	12	3 5/16	20.0	228.00
TBDA2-3613	36	13	3 5/16	21.0	235.00
TBDA2-3616	36	16	3 5/16	25.0	281.00

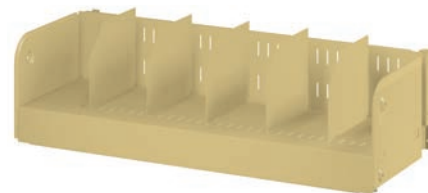

Slotted on 1" centers for dividers, with 5" backstop. Five adjustable dividers provided per shelf. Kickplates for adjustable base shelves are furnished with black powder coat finish. If 30" shelves are desired, change the number "36" to "30" (e.g. TBDF2-3010 or TBDA2-3010). Call factory for weights on 30" shelves.

CLOSED BASE SHELVES WITH INTEGRAL BACK AND DIVIDERS - DOUBLE FACE

CAT. NO.	W	D	H	WT.	PRICE
FOR FIXED BASE SHELVES					
TBDF2-3620	36	20	3 5/16	34.0	\$337.00
TBDF2-3624	36	24	3 5/16	37.0	363.00
TBDF2-3626	36	26	3 5/16	39.0	376.00
TBDF2-3632	36	32	3 5/16	47.0	458.00
FOR ADJUSTABLE BASE SHELVES					
TBDA2-3620	36	20	3 5/16	35.0	\$364.00
TBDA2-3624	36	24	3 5/16	38.0	395.00
TBDA2-3626	36	26	3 5/16	40.0	399.00
TBDA2-3632	36	32	3 5/16	48.0	487.00



Slotted on 1" centers for dividers, with 5" backstop. Five adjustable dividers provided per shelf. Kickplates for adjustable base shelves are furnished with black powder coat finish. If 30" shelves are desired, change the number "36" to "30" (e.g. TBDF2-3010 or TBDA2-3010). Call factory for weights on 30" shelves.

NOTE: MOST PRODUCTS AVAILABLE IN 24"W AT AN UPCHARGE OF 25%.

INTEGRAL BACK BASE SHELVING - SINGLE FACE

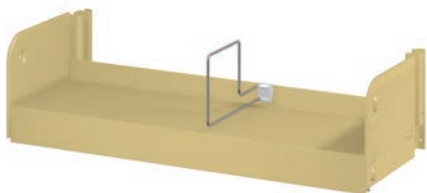

Includes one wire divider per opening and a 2" built-in backstop.
If adjustable base is required, change "WIBBS" to "WIBBSA" when ordering (e.g. WIBBSA2-wvddA).
Call factory for adjustable base pricing and weights.

CAT. NO.	W	D	H	WT.	PRICE
WIBBS2-3008A	30	8	3 5/16	10.2	\$185.00
WIBBS2-3009A	30	9	3 5/16	10.8	179.00
WIBBS2-3010A	30	10	3 5/16	12.0	179.00
WIBBS2-3012A	30	12	3 5/16	13.2	192.00
WIBBS2-3013A	30	13	3 5/16	14.6	211.00
WIBBS2-3016A	30	16	3 5/16	22.0	225.00
WIBBS2-3608A	36	8	3 5/16	11.2	185.00
WIBBS2-3609A	36	9	3 5/16	11.9	176.00
WIBBS2-3610A	36	10	3 5/16	13.2	179.00
WIBBS2-3612A	36	12	3 5/16	14.6	192.00
WIBBS2-3613A	36	13	3 5/16	15.5	211.00
WIBBS2-3616A	36	16	3 5/16	23.0	225.00
DIVIDER ONLY					
EWD-1	3/16	8	6 1/2	0.4	\$17.50
EWD-2	3/16	12	6 1/2	0.6	19.60

INTEGRAL BACK BASE SHELVES - DOUBLE FACE

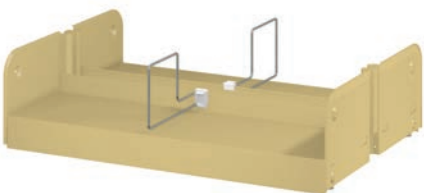

Includes one wire divider per opening and a 2" built-in backstop.
If adjustable base is required, change "WIBBS" to "WIBBSA" when ordering (e.g. WIBBSA2-wvddA).
Call factory for adjustable base pricing and weights.

CAT. NO.	W	D	H	WT.	PRICE
WIBBS2-3018A	30	18	3 5/16	19.6	\$284.00
WIBBS2-3020A	30	20	3 5/16	21.0	284.00
WIBBS2-3024A	30	24	3 5/16	25.0	314.00
WIBBS2-3026A	30	26	3 5/16	26.0	350.00
WIBBS2-3032A	30	32	3 5/16	31.0	399.00
WIBBS2-3618A	36	18	3 5/16	22.0	280.00
WIBBS2-3620A	36	20	3 5/16	24.0	286.00
WIBBS2-3624A	36	24	3 5/16	27.0	314.00
WIBBS2-3626A	36	26	3 5/16	29.0	350.00
WIBBS2-3632A	36	32	3 5/16	34.0	399.00
DIVIDER ONLY					
EWD-1	3/16	8	6 1/2	0.4	\$17.50
EWD-2	3/16	12	6 1/2	0.6	19.60

SLOPING BASE SHELVES - SINGLE FACE



WSB2-3612A

VC2-3612A

Sloping Base Shelves and Video Sloping Base Shelves are sloped at 9°, aiding visually those items displayed on the bottom shelf. Video Sloping Base Shelves are slotted on 1" centers for dividers, with 5" integral backstop; six adjustable dividers are provided.

CAT. NO.	W	D	H	WT.	PRICE
WSB2-3009A	30	9	3 7/8	11.6	\$181.00
WSB2-3010A	30	10	3 7/8	14.3	181.00
WSB2-3012A	30	12	3 7/8	15.6	181.00
WSB2-3609A	36	9	3 7/8	11.1	180.00
WSB2-3610A	36	10	3 7/8	15.0	181.00
WSB2-3612A	36	12	3 7/8	15.6	182.00
VIDEO SLOPING BASE SHELVES (6 DIVIDERS INCLUDED)					
VC2-3012A	30	12	3 7/8	19.1	\$248.00
VC2-3612A	36	12	3 7/8	20.0	249.00

SLOPING BASE SHELVES - DOUBLE FACE



WSB2-3624A

VC2-3612DA

Sloping Base Shelves and Video Sloping Base Shelves are sloped at 9°, aiding visually those items displayed on the bottom shelf. Video Sloping Base Shelves are slotted on 1" centers for dividers, with 5" integral backstop; twelve adjustable dividers are provided.

CAT. NO.	W	D	H	WT.	PRICE
WSB2-3018A	30	18	3 7/8	24.0	\$293.00
WSB2-3020A	30	20	3 7/8	24.0	309.00
WSB2-3024A	30	24	3 7/8	31.0	312.00
WSB2-3618A	36	18	3 7/8	23.0	291.00
WSB2-3620A	36	20	3 7/8	26.0	307.00
WSB2-3624A	36	24	3 7/8	31.0	311.00
VIDEO SLOPING BASE SHELVES (12 DIVIDERS INCLUDED)					
VC2-3012DA	30	24	3 7/8	38.0	\$443.00
VC2-3612DA	36	24	3 7/8	40.0	443.00

NOTE: MOST PRODUCTS AVAILABLE IN 24"W AT AN UPCHARGE OF 25%.

ADJUSTABLE SHELVES

CAT. NO.	W	D	H	WT.	PRICE
BL3008A	30	8	13/16	5.9	\$60.00
BL3009A	30	9	13/16	6.6	68.00
BL3010A	30	10	13/16	7.2	69.00
BL3011A	30	11	13/16	7.9	76.00
BL3012A	30	12	13/16	8.6	77.00
BL3013A	30	13	13/16	9.2	95.00
BL3014A	30	14	13/16	9.9	97.00
BL3016A	30	16	13/16	11.2	110.00
BL3608A	36	8	13/16	6.7	60.00
BL3609A	36	9	13/16	7.5	68.00
BL3610A	36	10	13/16	8.2	69.00
BL3611A	36	11	13/16	9.0	76.00
BL3612A	36	12	13/16	9.8	77.00
BL3613A	36	13	13/16	10.5	95.00
BL3614A	36	14	13/16	11.3	97.00
BL3616A	36	16	13/16	12.8	110.00

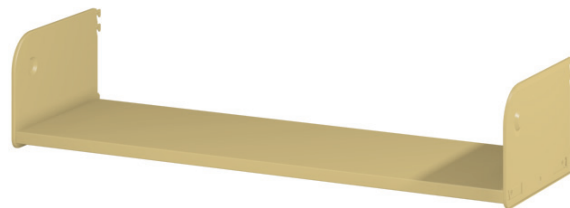

Includes shelf brackets. Can be furnished in additional widths or depths; contact factory for pricing.

ADJUSTABLE DIVIDER SHELVES

CAT. NO.	W	D	H	WT.	PRICE
BDA3010A	30	10	13/16	12.8	\$131.00
BDA3011A	30	11	13/16	13.5	137.00
BDA3012A	30	12	13/16	14.2	141.00
BDA3013A	30	13	13/16	14.8	141.00
BDA3016A	30	16	13/16	17.9	181.00
BDA3610A	36	10	13/16	14.1	131.00
BDA3611A	36	11	13/16	14.9	137.00
BDA3612A	36	12	13/16	15.7	141.00
BDA3613A	36	13	13/16	16.4	149.00
BDA3616A	36	16	13/16	20.0	185.00

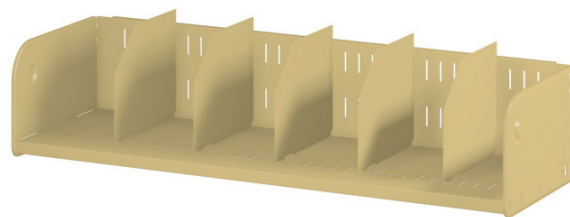

Slotted on 1" centers to accommodate dividers. Includes 5" back, brackets and 5 adjustable dividers per shelf.

SHELF BRACKETS

CAT. NO.	W	D	H	WT.	PRICE
ASBRK08L*	1/4	8	7 1/2	1.0	\$9.20
ASBRK09L*	1/4	9	7 1/2	1.1	10.20
ASBRK10L*	1/4	10	7 1/2	1.2	10.50
ASBRK11L*	1/4	11	7 1/2	1.4	12.20
ASBRK12L*	1/4	12	7 1/2	1.5	12.70
ASBRK13L*	1/4	13	7 1/2	1.6	14.70
ASBRK14L*	1/4	14	7 1/2	1.8	15.10
ASBRK16L*	1/4	16	7 1/2	2.0	18.10



LEFT BRACKET



RIGHT BRACKET

Attaches shelves to unit uprights. *NOTE: Listed catalog numbers are for left bracket only; for right bracket, change the suffix "L" to "R".

DIVIDERS

CAT. NO.	USE WITH	D	H	WT.	PRICE
DIV07	7"-9" Shelves	7	6	0.4	\$4.80
DIV09	10" through 13"	9	7 1/2	0.7	6.60
DIV12	14" through 16"	12	7 1/2	1.0	9.20
SPD12	14" through 16"	9	12	1.6	19.30



DIV07

DIV09

DIV12

SPD12

SHIMS

CAT. NO.	W	D	H	WT.	PRICE
SHIM	2	2 1/2	1/16	0.1	\$2.10

Used to aid in the leveling of fixed base units. Zinc finish.



NOTE: MOST PRODUCTS AVAILABLE IN 24"W AT AN UPCHARGE OF 25%.

HINGED PERIODICAL DISPLAY SHELVES



PERIODICAL DISPLAY SHELF

Sloped for display. 14" high periodical surface.

*Includes continuous label holder.



PERIODICAL DISPLAY SHELF WITH PLEXIGLASS COVER

CAT. NO.	W	D	H	WT.	PRICE
PDS3012A	30	12	14	15.5	\$153.00
PDS3612A	36	12	14	18.0	485.00
PDS3012AC LH*	30	12	14	14.9	185.00
PDS3612AC LH*	36	12	14	18.0	185.00
WITH PLEXIGLASS COVER					
PDSCA30	30	12	14	22.0	\$370.00
PDSCA	36	12	14	23.0	370.00

FIXED SLOPED DISPLAY SHELVES



SLOPED DISPLAY SHELF

Sloped for display. 12" periodical surface.

*Includes continuous label holder.

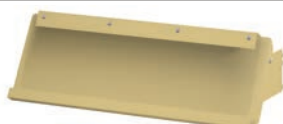

SLOPED DISPLAY SHELF WITH PLEXIGLASS COVER

CAT. NO.	W	D	H	WT.	PRICE
SDS3012A	30	12	12	7.3	\$124.00
SDS3612A	36	12	12	9.6	124.00
SDS3012AC LH*	30	12	12	13.1	209.00
SDS3612AC LH*	36	12	12	9.2	184.00
WITH PLEXIGLASS COVER					
SDSCA30	30	12	12	11.8	\$360.00
SDSCA	36	12	12	11.8	364.00

INTEGRAL BACK SHELVES

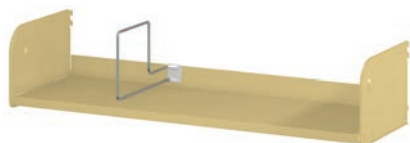

Built-in 2" backstop keeps items organized. Includes brackets and one wire divider per shelf. For 30" shelf, change "BLIB36" to "BLIB30" (e.g. BLIB3016A).

CAT. NO.	W	D	H	WT.	PRICE
BLIB3608A	36	8	13/16	7.5	\$84.00
BLIB3609A	36	9	13/16	8.3	90.00
BLIB3610A	36	10	13/16	9.0	92.00
BLIB3611A	36	11	13/16	9.8	101.00
BLIB3612A	36	12	13/16	10.8	109.00
BLIB3613A	36	13	13/16	11.5	122.00
BLIB3616A	36	16	13/16	13.8	140.00

SLOPED INTEGRAL BACK SHELVES



Shelves have a 7° slope.

Built-in 2" backstop keeps items from falling off sloped shelf. For 30" shelf, change "SIBS36" to "SIBS30" (e.g. SIBS3016A).

CAT. NO.	W	D	H	WT.	PRICE
SIBS3608A	36	8	13/16	7.4	\$71.00
SIBS3609A	36	9	13/16	8.1	75.00
SIBS3610A	36	10	13/16	8.8	79.00
SIBS3611A	36	11	13/16	9.7	88.00
SIBS3612A	36	12	13/16	10.4	94.00

MULTIPURPOSE DISPLAY SHELVES



AS SLOPING DISPLAY SHELF

Two-positional shelf allows you to have either a sloping display shelf or (reversed) an integral back shelf. Ideal for displaying video tapes, audio cassettes, art books, etc.



AS INTEGRAL BACK SHELF

CAT. NO.	TYPE	W	D	H	WT.	PRICE
MP3610A	No Dividers	36	10	8	10.2	\$115.00
MPD3610A	With Dividers	36	10	8	12.4	141.00

Divider shelves come with 6 dividers.

MULTIPURPOSE BASE SHELVES



SINGLE ENTRY

Two-positional shelf can be used as either a sloping display shelf or (reversed) an integral back shelf. Divider shelves come with 6 dividers.



DOUBLE ENTRY

CAT. NO.	TYPE	W	D	H	WT.	PRICE
SINGLE ENTRY						
MPB2-3610A	No Dividers	36	10	8	15.6	\$191.00
MPDB2-3610A	With Dividers	36	10	8	17.8	217.00
DOUBLE ENTRY						
MPB2-3620A	No Dividers	36	20	8	38.0	\$330.00
MPDB2-3620A	With Dividers	36	20	8	42.0	385.00

NOTE: MOST PRODUCTS AVAILABLE IN 24"W AT AN UPCHARGE OF 25%.

STORAGE SHELVES

CAT. NO.	W	D	H	WT.	PRICE
IN3610A	36	10	13/16	6.9	\$62.00
IN3612A	36	12	13/16	8.1	68.00
IN3613A	36	13	13/16	8.6	80.00
IN3614A	36	14	13/16	9.5	85.00
IN3616A	36	16	13/16	10.5	93.00
IN3618A	36	18	13/16	11.7	108.00
IN3619A	36	19	13/16	12.4	113.00



Used with sloped display shelves (at left on page 16), or any place where a flat shelf is desired. For 30" shelf, change "IN36" to "IN30" (e.g. IN3010A)

FACE-OUT DISPLAY SHELF

CAT. NO.	W	D	H	WT.	PRICE
FODSA	36	2 3/4	5 9/16	6.2	\$100.00

Used to display compact discs and DVDs. Shelf has a 7° slope.



VIDEO CASSETTE/PAPERBACK BOOK SHELF

CAT. NO.	W	D	H	WT.	PRICE
VCS3007A	30	6	7 1/2	11.5	\$117.00
VCS3008A	30	7	7 1/2	10.6	124.00
VCS3607A	36	6	7 1/2	10.8	117.00
VCS3608A	36	7	7 1/2	11.5	124.00
DIV07	(DIVIDER ONLY)			0.4	\$4.80

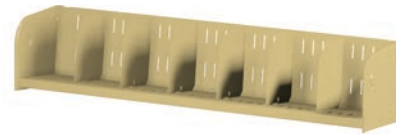

Slopes to allow convenient viewing of spines on paperbacks and video cassettes. Six adjustable dividers included per shelf.

SLIDING REFERENCE SHELVES*

*Brackets included.

CAT. NO.	W	D	H	WT.	PRICE
SRS3008A	30	8	3	9.2	\$356.00
SRS3009A	30	9	3	8.2	305.00
SRS3010A	30	10	3	13.1	350.00
SRS3012A	30	12	3	15.6	402.00
SRS3608A	36	8	3	9.2	356.00
SRS3609A	36	9	3	8.2	305.00
SRS3610A	36	10	3	14.0	402.00
SRS3612A	36	12	3	16.6	402.00



Sturdy full extension slides attach to underside of adjustable shelf. Use two reference shelves for double face units.

ZIG-ZAG SHELF

CAT. NO.	W	D	H	WT.	PRICE
ZZ3008A	30	7	5 13/16	10.1	\$164.00
ZZ3608A	36	7	5 13/16	10.9	160.00
INSERT ONLY					
ZZPD	36	18	5	3.8	\$94.00



ZZ3608A

Adjustable shelf with paperback insert. Ideal for displaying audio cassette or paperback books.

NOTE: MOST PRODUCTS AVAILABLE IN 24"W AT AN UPCHARGE OF 25%.

CABINET



All welded construction. Ideal for storing valuable items that need to be secured.
Includes flipper door and lock with two keys.

CAT. NO.	W	D	H	WT.	PRICE
CABINET ONLY					
FDCB36L	36	17 5/8	15 1/2	53.0	\$1,931.00

MEDIA HANGER RACK



Consists of brackets with hanger rod for clear-view plastic media bags.

CAT. NO.	W	D	H	WT.	PRICE
HB30A	30	6 1/2	4 1/4	2.1	\$125.00
HB36A	36	6 1/2	4 1/4	2.1	125.00

WORK SHELF AND BRACKETS



WORK SHELF WITH BRACKETS

LEGS

CAT. NO.	W	D	H	WT.	PRICE
LC54A	36	24	27 1/2	30.0	\$1,431.00
LCL (Legs Only, Per Pair)				3.0	182.00
LCBRK24L (Left Bracket Only)				3.6	183.00
LCBRK24R (Right Bracket Only)				3.6	183.00

24" deep plastic laminate shelf supported by two steel triangular brackets for work surface with shelving range. Must state desired finish of work shelf.

METAL BROWSING BOX



BROWSING BOX

DIVIDER

Ideal for storing all media items.
Includes 2 wire dividers.

CAT. NO.	W	D	H	WT.	PRICE
BRB3005A	30	14 1/2	5 1/2	13.5	\$389.00
BRB3605A	36	14 1/2	5 1/2	15.3	618.00
BRBWD (Divider Only)				0.1	13.30

PULL-OUT BROWSING BOX

A pull out browsing box mounted on full extension ball-bearing suspensions. Ideal for storing all media items. XBRB3611A includes 2 wire dividers; XHDBRB3611A includes 4 plate type dividers.



XBRB43611A

XHDBRB3611A

CAT. NO.	W	D	H	WT.	PRICE
WITH SLIDING DIVIDER					
XBRB43611A	36	11 1/2	5 1/2	29.0	\$815.00
TXBWD (Divider Only)				0.3	25.00
WITH PLATE-TYPE DIVIDER and 3" FRONT					
XHDBRB3611A	36	11 1/2	5 1/2	31.0	\$951.00
BRBDIVA (Divider Only)				0.4	8.50

2" Weld Frame

NOTE: MOST PRODUCTS AVAILABLE IN 24"W AT AN UPCHARGE OF 25%.

NEWSPAPER RACK

CAT. NO.	TYPE	W	D	H	WT.	PRICE
NPR6	6 Holders	36	12	14	9.6	\$1,591.00
NPR10	10 Holders	36	12	22	15.2	2,349.00

Displays newspapers. Newspaper sticks included.



WALL HUNG COLUMNS

CAT. NO.	W	D	H	WT.	PRICE
PILWCH24	1 1/2	1	24	2.4	\$73.00
PILWCH30	1 1/2	1	30	2.4	73.00
PILWCH42	1 1/2	1	42	3.1	73.00
PILWCH54	1 1/2	1	54	3.8	78.00
PILWCH60	1 1/2	1	60	3.8	83.00
PILWCH66	1 1/2	1	66	3.8	94.00
PILWCH72	1 1/2	1	72	4.5	85.00
PILWCH78	1 1/2	1	78	4.5	90.00
PILWCH84	1 1/2	1	84	4.8	91.00
PILWCH90	1 1/2	1	90	5.2	94.00



Slotted strip attaches to wall. Designed to accept all components or accessory items. Special heights available. Hardware not included because of various wall construction.

CARD HOLDERS

CAT. NO.	W	D	H	WT.	PRICE
SINGLE CARD HOLDER					
SCH-B	5 1/4	—	3 1/8	0.1	\$6.50
DOUBLE CARD HOLDER					
DCH-B	10 1/4	—	3 1/8	0.2	\$8.10
ALUMINUM HOLDER					
SCH-CA	5 5/8	—	3 1/2	0.1	\$6.40



SCH-B



DCH-B



SCH-CA

For 3" x 5" cards. Used on end panels. Attaches with double-sided tape. Steel holders are finished in black powder coat paint.

TRANSVERSE OVERHEAD TOP TIE BRACING

CAT. NO.	W	D	H	WT.	PRICE
FOR WELD FRAME					
OTBW9	96	2	7/8	5.7	\$56.00

Channel construction top tie furnished in 8 foot lengths. Recommended for added stabilization when bases and shelves are of equal depths.



SHELF LABEL HOLDER

CAT. NO.	W	D	H	WT.	PRICE
SLH	5 1/2	2	3 3/4	0.1	\$2.20

Plastic clip-on holder 5/8" x 5" card. (Paper not included)



WALL CLIP

CAT. NO.	W	D	H	WT.	PRICE
WCLIP	3	2	1	0.2	\$2.00

Used to attach single face units to the wall for support. Wall hardware not included.



RANGE FINDER

CAT. NO.	W	D	H	WT.	PRICE
RFP6	—	6 3/4	3 1/8	0.2	\$9.00

For use on end panels or uprights for identification of range contents. Attaches with double-sided tape. Holds two 3" x 5" cards. Finished in black.



NOTE: MOST PRODUCTS AVAILABLE IN 24"W AT AN UPCHARGE OF 25%.

STEEL BOOK SUPPORTS



CAT. NO.	W	D	H	WT.	PRICE
WITH CORK BACKING					
BSN6	4 9/16	5 1/2	6	0.6	\$11.50
BSN9	4 9/16	5 1/2	9	1.1	14.00
WITH MAGNETIC STRIP					
BSM6	4 9/16	5 1/2	6	1.0	\$11.50
BSM9	4 9/16	5 1/2	9	1.1	14.00

Unattached book support used on surface of shelves. Furnished with cork backing or a magnetic strip, as specified above.

WIRE BOOK SUPPORTS



6-INCH "V" SUPPORT



7-INCH "W" SUPPORT



9-INCH "V" SUPPORT



9-INCH "W" SUPPORT

CAT. NO.	TYPE	W	D	H	WT.	PRICE
WBS6	"V"	3/16	—	6	0.2	\$7.30
WBS9	"V"	3/16	—	9	0.3	8.10
WBSW7	"W"	3/16	—	7	0.3	9.50
WBSW9	"W"	3/16	—	9	0.4	11.20

Heavy spring wire book support. Attaches to underside of shelf. Easily adjustable.

SHELF FILLER



CAT. NO.	W	D	H	WT.	PRICE
SHFIL2-30	27	2	1	2.3	\$45.00
SHFIL2-36	33	2	1	2.6	45.00

Fills the space between adjustable shelves on double sided units, providing a continuous surface. Attaches with two clips that fasten to underside of shelves.

SLOPED ADJUSTABLE END BRACKET



LEFT BRACKET



RIGHT BRACKET

CAT. NO.	W	D	H	WT.	PRICE
SASBRK08LJ*	1/4	8	7 1/2	1.1	\$11.30
SASBRK09LJ*	1/4	9	7 1/2	1.2	11.30
SASBRK10LJ*	1/4	10	7 1/2	1.3	12.90
SASBRK11LJ*	1/4	11	7 1/2	1.5	14.30
SASBRK12LJ*	1/4	12	7 1/2	1.6	15.00
SASBRK13LJ*	1/4	13	7 1/2	1.7	15.80
SASBRK14LJ*	1/4	14	7 1/2	1.9	23.00

Creates 7 degrees of slope for an adjustable shelf. *NOTE: Listed catalog numbers are for left bracket only; for right bracket, change the suffix "LJ" to "RJ".

2" Weld Frame

NOTE: MOST PRODUCTS AVAILABLE IN 24"W AT AN UPCHARGE OF 25%.

BASE FILLER CLOSURES

CAT. NO.	W	D	H	WT.	PRICE
FOR WELD FRAME					
BFC2-30	30	2	1	2.0	\$15.70
BFC2-36	36	2	1	1.6	15.70

Use to fill space between uprights when an adjustable base is used.

CAT. NO.	W	D	H	WT.	PRICE
FOR MOBILE CARRIAGE					
BCC30-2	30	2	1 3/4	2.1	\$32.00
BCC36-2	36	2	1 3/4	2.5	38.00

Use to fill space between uprights when adjustable shelves are used on bottom of unit.

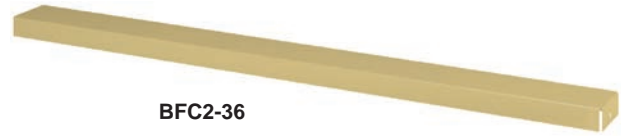

BFC2-36

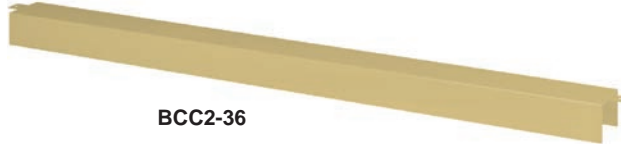

BCC2-36

ADJUSTABLE BACKSTOP

CAT. NO.	W	D	H	WT.	PRICE
ABS36	36	7/16	2	1.5	\$25.00

Individual backstop designed to engage in upright slots for adjustability.



REVERSIBLE BACKSTOP – WIRE DIVIDER

CAT. NO.	W	D	H	WT.	PRICE
BACK STOP					
RBS30	30	7/16	2	1.2	\$14.40
RBS36	36	7/16	2	1.3	14.40
WIRE DIVIDER					
BSWBS	—	8 1/2	4	0.2	\$6.30

One side is a regular backstop. The other side is a sliding support backstop (when used with wire divider sold above).



OFFSET CENTER BACKSTOP – LARGE PROFILE

CAT. NO.	W	D	H	WT.	PRICE
CBS30	30	3/8	3 9/32	1.7	\$41.00
CBS36	36	3/8	3 9/32	2.1	41.00

Works as a backstop for each side of a double entry unit, eliminating the need for an individual backstop for each side.



OFFSET CENTER BACKSTOP – SMALL PROFILE

CAT. NO.	W	D	H	WT.	PRICE
CBSS30	30	7/16	2	1.4	\$19.30
CBSS36	36	7/16	2	1.6	19.30

Works as a backstop for each side of a double entry unit, eliminating the need for an individual backstop for each side.



FLOOR ANCHOR

CAT. NO.	W	D	H	WT.	PRICE
FLRANCH3	1	3	5/8	0.1	\$4.80

Used to anchor weld frame units to the floor. For use with weld frame base brackets only. Zinc plated

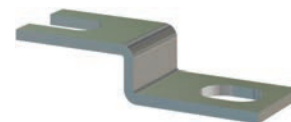

NOTE: MOST PRODUCTS AVAILABLE IN 24"W AT AN UPCHARGE OF 25%.

STEEL CANOPY TOPS



SINGLE FACE (CTS2)

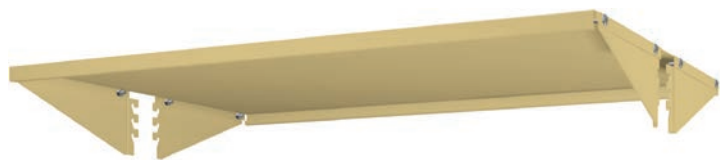

DOUBLE FACE (CTD)



BRACKETS WITH HARDWARE

Keeps dust off your valuable materials. Includes attaching brackets.

*Attaching bracket is also used to secure steel end panels (see page 24). Each pair consists of one left and one right bracket.

CAT. NO.	W	D	H	WT.	PRICE
SINGLE FACE					
CTS2-3008	30	8	—	6.0	\$73.00
CTS2-3009	30	9	—	6.5	76.00
CTS2-3010	30	10	—	7.0	73.00
CTS2-3012	30	12	—	8.2	77.00
CTS2-3013	30	13	—	8.9	95.00
CTS2-3016	30	16	—	10.4	115.00
CTS2-3608	36	8	—	6.9	73.00
CTS2-3609	36	9	—	7.5	76.00
CTS2-3610	36	10	—	8.1	73.00
CTS2-3612	36	12	—	9.5	77.00
CTS2-3613	36	13	—	10.2	95.00
CTS2-3616	36	16	—	12.1	113.00
DOUBLE FACE					
CTD3016	30	16	—	9.3	\$126.00
CTD3018	30	18	—	10.2	134.00
CTD3020	30	20	—	11.3	125.00
CTD3024	30	24	—	13.5	139.00
CTD3026	30	26	—	14.8	176.00
CTD3032	30	32	—	17.9	214.00
CTD3616	36	16	—	10.8	123.00
CTD3618	36	18	—	11.8	133.00
CTD3620	36	20	—	13.0	125.00
CTD3624	36	24	—	15.6	139.00
CTD3626	36	26	—	16.9	176.00
CTD3632	36	32	—	20.0	223.00
BRACKETS WITH HARDWARE					
CTB08S	—	8	—	1.2	\$22.00
CTB09S	—	9	—	1.3	25.00
CTB10S	—	10	—	1.4	18.80
CTB12S	—	12	—	1.8	21.00
CTB13S	—	13	—	2.0	31.00
CTB16S	—	16	—	2.4	39.00

CANOPY BRACKETS FOR WOOD TOPS



BRACKETS ONLY

Used when wood or hard plastic canopy tops are used. For single face units, use 1 pair. For double face units, use 2 pairs. Each pair consists of one left and one right bracket. Wood top and hardware not included.

CAT. NO.	DEPTH	WT.	PRICE
BRACKETS ONLY			
CTIB08S (1 Pair)	8	1.0	\$22.00
CTIB09S (1 Pair)	9	1.1	25.00
CTIB10S (1 Pair)	10	1.2	18.80
CTIB12S (1 Pair)	12	1.6	21.00
CTIB13S (1 Pair)	13	1.8	31.00
CTIB16S (1 Pair)	16	2.2	39.00
CTIB18S (1 Pair)	18	2.6	44.00

CANOPY SIGNAGE



CAT. NO.	W	D	H	WT.	PRICE
CPSGN36	35 1/4	—	1 3/4	1.5	\$207.00

Material in aluminum. Cannot be painted.

Easily identify special items or sections with this customizable label holder. Three attachment clips provided.

2" Weld Frame

NOTE: MOST PRODUCTS AVAILABLE IN 24"W AT AN UPCHARGE OF 25%.

FIXED BASE/ADJUSTABLE BASE REINFORCING GUSSETS

CAT. NO.	W	D	H	WT.	PRICE
SINGLE FACE					
GS2-08AL (left)	1/16	8	39 7/8	5.0	\$91.00
GS2-08AR (right)	1/16	8	39 7/8	5.0	91.00
GS2-09AL (left)	1/16	9	39 7/8	6.3	104.00
GS2-09AR (right)	1/16	9	39 7/8	6.3	104.00
GS2-10AL (left)	1/16	10	39 7/8	6.2	103.00
GS2-10AR (right)	1/16	10	39 7/8	6.2	103.00
GS2-12AL (left)	1/16	12	39 7/8	6.2	116.00
GS2-12AR (right)	1/16	12	39 7/8	6.2	116.00
GS2-13AL (left)	1/16	13	39 7/8	8.5	126.00
GS2-13AR (right)	1/16	13	39 7/8	8.5	126.00
GS2-16AL (left)	1/16	16	39 7/8	7.8	141.00
GS2-16AR (right)	1/16	16	39 7/8	7.8	128.00
DOUBLE FACE					
GD2-081A	1/16	16	39 7/8	8.2	\$108.00
GD2-091A	1/16	18	39 7/8	6.6	118.00
GD2-101A	1/16	20	39 7/8	8.7	134.00
GD2-121A	1/16	24	39 7/8	9.7	149.00
GD2-131A	1/16	26	39 7/8	13.6	157.00
GD2-161A	1/16	32	39 7/8	13.9	194.00



Used when fixed base shelving units are to be mounted on mobile carriage bases or when additional stabilization is required. Also available for adjustable base shelving units; to order, add "J" to end of catalog number and call factory for pricing and weights. (e.g. GS2-16LJA)

MOBILE CARRIAGE REINFORCING GUSSETS

CAT. NO.	W	D	H	WT.	PRICE
SINGLE FACE					
GS2-08CAL (left)	1/16	8	39 7/8	5.5	\$88.00
GS2-08CAR (right)	1/16	8	39 7/8	5.5	88.00
GS2-09CAL (left)	1/16	9	39 7/8	6.1	95.00
GS2-09CAR (right)	1/16	9	39 7/8	6.1	95.00
GS2-10CAL (left)	1/16	10	39 7/8	6.6	102.00
GS2-10CAR (right)	1/16	10	39 7/8	6.6	102.00
GS2-12CAL (left)	1/16	12	39 7/8	5.1	113.00
GS2-12CAR (right)	1/16	12	39 7/8	5.1	112.00
GS2-13CAL (left)	1/16	13	39 7/8	8.4	116.00
GS2-13CAR (right)	1/16	13	39 7/8	8.4	116.00
GS2-16CAL (left)	1/16	16	39 7/8	10.1	140.00
GS2-16CAR (right)	1/16	16	39 7/8	10.1	140.00
DOUBLE FACE					
GD2-08CA	1/16	16	39 7/8	6.7	\$118.00
GD2-09CA	1/16	18	39 7/8	7.4	122.00
GD2-10CA	1/16	20	39 7/8	8.3	134.00
GD2-12CA	1/16	24	39 7/8	8.7	149.00
GD2-13CA	1/16	26	39 7/8	10.4	162.00
GD2-16CA	1/16	32	39 7/8	12.6	198.00



Used when adjustable shelves (in lieu of a base shelf and base bracket) are used as a base and are to be mounted on mobile carriage tracks only.

CORNER FILLERS

CAT. NO.	HEIGHTS	DEPTHS	WT.	PRICE
SCF2-hhddA	42" to 93"	8" to 32"		CALL FACTORY

Used to make a corner for units placed at right angles to each other. Available in all heights and depths. Specify height and depth (hhdd) when ordering.

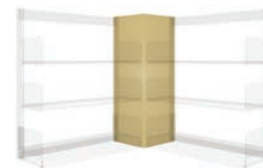

INTERMEDIATE WALL FILLERS

CAT. NO.	HEIGHTS	DEPTHS	WT.	PRICE
DCF2-hhddA	42" to 93"	8" to 32"		CALL FACTORY

Used to fill a void where two single faced units are joined at a right angle with a double faced unit. Available for all base shelf depths and frame heights. Specify height and depth (hhdd) when ordering.



NOTE: MOST PRODUCTS AVAILABLE IN 24"W AT AN UPCHARGE OF 25%.

END PANELS



SINGLE FACE

CAT. NO.	BASE DEPTH	HEIGHT	WT.	PRICE
WSP2-4208A	8	42	13.5	\$204.00
WSP2-4209A	9	42	12.5	209.00
WSP2-4210A	10	42	13.1	219.00
WSP2-4212A	12	42	14.5	219.00
WSP2-4213A	13	42	14.9	228.00
WSP2-4216A	16	42	16.7	265.00
WSP2-6608A	8	66	18.5	265.00
WSP2-6609A	9	66	19.5	272.00
WSP2-6610A	10	66	21.0	277.00
WSP2-6612A	12	66	25.0	284.00
WSP2-6613A	13	66	23.0	301.00
WSP2-6616A	16	66	26.0	343.00
WSP2-7808A	8	78	22.0	293.00
WSP2-7809A	9	78	23.0	301.00
WSP2-7810A	10	78	24.0	295.00
WSP2-7812A	12	78	27.0	306.00
WSP2-7813A	13	78	27.0	336.00
WSP2-7816A	16	78	31.0	365.00
WSP2-8408A	8	84	24.0	308.00
WSP2-8409A	9	84	25.0	301.00
WSP2-8410A	10	84	26.0	312.00
WSP2-8412A	12	84	26.0	323.00
WSP2-8413A	13	84	30.0	356.00
WSP2-8416A	16	84	33.0	371.00
WSP2-9008A	8	90	25.0	322.00
WSP2-9009A	9	90	27.0	332.00
WSP2-9010A	10	90	27.0	322.00
WSP2-9012A	12	90	31.0	343.00
WSP2-9013A	13	90	32.0	372.00
WSP2-9016A	16	90	36.0	333.00
WSP2-9308A	8	93	26.0	385.00
WSP2-9309A	9	93	27.0	393.00
WSP2-9310A	10	93	29.0	405.00
WSP2-9312A	12	93	31.0	426.00
WSP2-9313A	13	93	33.0	437.00
WSP2-9316A	16	93	37.0	468.00

DOUBLE FACE

CAT. NO.	BASE DEPTH	HEIGHT	WT.	PRICE
WDP2-4216A	16	42	21.0	\$407.00
WDP2-4218A	18	42	22.0	389.00
WDP2-4220A	20	42	24.0	385.00
WDP2-4224A	24	42	24.0	427.00
WDP2-4226A	26	42	28.0	449.00
WDP2-4232A	32	42	23.0	476.00
WDP2-6616A	16	66	30.0	483.00
WDP2-6618A	18	66	24.0	496.00
WDP2-6620A	20	66	34.0	498.00
WDP2-6624A	24	66	38.0	537.00
WDP2-6626A	26	66	40.0	577.00
WDP2-6632A	32	66	46.0	623.00
WDP2-7816A	16	78	35.0	525.00
WDP2-7818A	18	78	37.0	540.00
WDP2-7820A	20	78	39.0	551.00
WDP2-7824A	24	78	45.0	571.00
WDP2-7826A	26	78	46.0	630.00
WDP2-7832A	32	78	53.0	683.00
WDP2-8416A	16	84	37.0	553.00
WDP2-8418A	18	84	39.0	573.00
WDP2-8420A	20	84	33.0	595.00
WDP2-8424A	24	84	37.0	604.00
WDP2-8426A	26	84	49.0	669.00
WDP2-8432A	32	84	57.0	724.00
WDP2-9016A	16	90	41.0	570.00
WDP2-9018A	18	90	42.0	589.00
WDP2-9020A	20	90	46.0	600.00
WDP2-9024A	24	90	52.0	631.00
WDP2-9026A	26	90	52.0	692.00
WDP2-9032A	32	90	60.0	760.00
WDP2-9316A	16	93	40.0	601.00
WDP2-9318A	18	93	43.0	620.00
WDP2-9320A	20	93	46.0	643.00
WDP2-9324A	24	93	54.0	721.00
WDP2-9326A	26	93	54.0	714.00
WDP2-9332A	32	93	62.0	783.00

Optional attaching brackets available for added stability; see page 22.

STEEL BACKS



CAT. NO.	W	D	H	WT.	PRICE
WNB3042A	30	1	42	17.9	\$291.00
WNB3066A	30	1	66	30.0	455.00
WNB3078A	30	1	78	36.0	524.00
WNB3084A	30	1	84	39.0	541.00
WNB3090A	30	1	90	42.0	569.00
WNB3642A	36	1	42	21.0	291.00
WNB3666A	36	1	66	35.0	455.00
WNB3678A	36	1	78	42.0	524.00
WNB3684A	36	1	84	46.0	541.00
WNB3690A	36	1	90	49.0	569.00

24" wide backs are available at a 25% upcharge. Contact factory for weights.

2" Weld Frame

Single Face

CAT. NO.	W	D	H	WT.	PRICE
STARTER UNITS					
DSS4236S	36	13	42	63	\$1,209.00
DSS5436S	36	14	54	76	1,337.00
DSS6636S	36	16	66	93	1,397.00

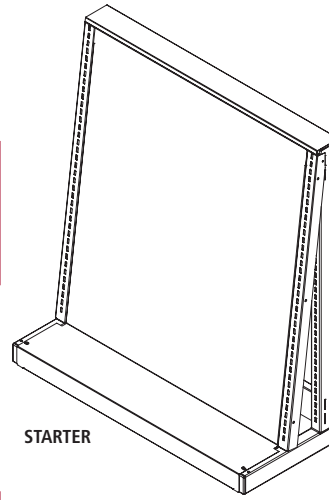

STARTER

DSS5436S

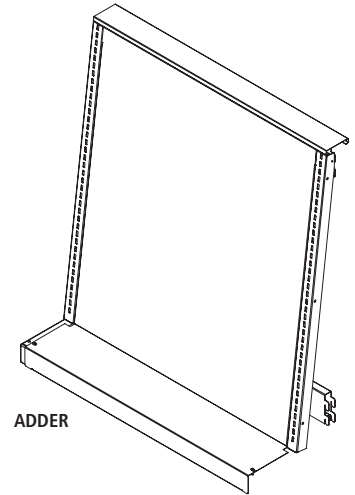

ADDER

DSS5436A

CAT. NO.	W	D	H	WT.	PRICE
ADDER UNITS					
DSS4236A	36	13	42	50	\$891.00
DSS5436A	36	14	54	61	967.00
DSS6636A	36	16	66	71	1,020.00

Upright assembly gives the shelving a clean, contemporary look and added strength without compromising aisle space or storage capacity.

NOTE: Assemblies do NOT include accessories. Add accessories to create a functional shelving unit.

Double Face

CAT. NO.	W	D	H	WT.	PRICE
STARTER UNITS					
DSD4236S	36	26	42	101	\$1,628.00
DSD5436S	36	28	54	125	1,814.00
DSD6636S	36	32	66	149	1,934.00

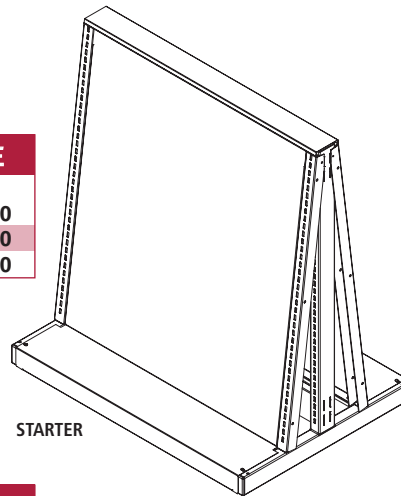

STARTER

DSD5436S

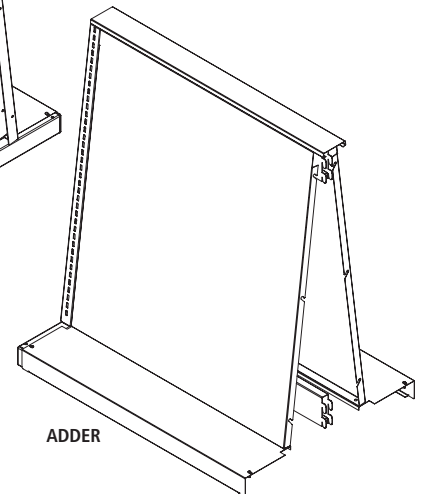

ADDER

DSD5436A

CAT. NO.	W	D	H	WT.	PRICE
ADDER UNITS					
DSD4236A	36	26	42	82	\$1,238.00
DSD5436A	36	28	54	104	1,355.00
DSD6636A	36	32	66	121	1,461.00

Upright assembly gives the shelving a clean, contemporary look and added strength without compromising aisle space or storage capacity.

NOTE: Assemblies do NOT include accessories. Add accessories to create a functional shelving unit.

DIVIDER BROWSER SHELF

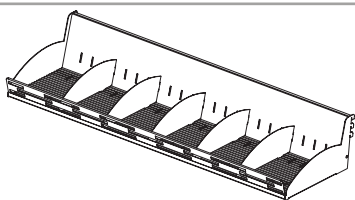

CAT. NO.	W	D	H	WT.	PRICE
BRS3611A	36	12	6	13.4	\$409.00
EXTRA DIVIDER					
BRSDIV11	3/64	10	3 3/64	0.4	\$6.60

Ideal for storing a wide variety of media items. Shelf includes 5 dividers and an attractive front profile.

MAGAZINE SHELF

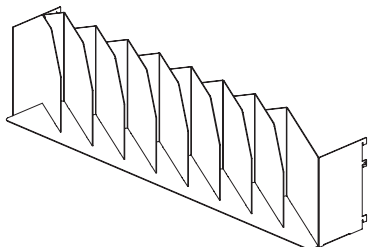

CAT. NO.	W	D	H	WT.	PRICE
DSDMS36LF	36	7	8	18.3	\$612.00

Perfect for any retail environment, our magazine shelf includes 8 fixed dividers to showcase your periodicals.

MEDIA/PAPERBACK SHELF

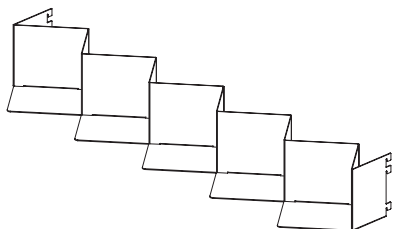

CAT. NO.	W	D	H	WT.	PRICE
DSDAV36	36	8	5	7.2	\$216.00

Our zig-zag design is the perfect solution when displaying Blu-rays, DVDs, CDs, audio books, paperbacks and more.

FLAT SHELVES

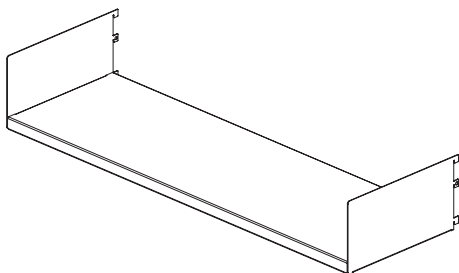

CAT. NO.	W	D	H	WT.	PRICE
ED3608A	36	8	6	7.1	\$73.00
ED3609A	36	9	6	7.8	\$83.00
ED3610A	36	10	6	8.6	\$78.00
ED3611A	36	11	6	9.5	\$84.00
ED3612A	36	12	6	10.2	\$87.00

Display hard backed books and other media with our attractive, adjustable shelf.

CASTER KITS

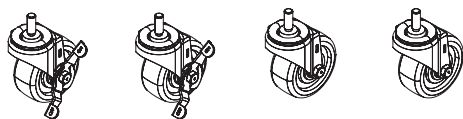

DSK-5

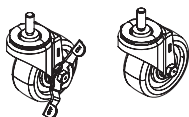

DSK-A

CAT. NO.	W	D	H	WT.	PRICE
CASTER KIT FOR STARTER UNIT					
DSCK-S	2 with brakes, 2 without brakes			4.0	\$322.00

CAT. NO.	W	D	H	WT.	PRICE
CASTER KIT FOR ADDER UNIT					
DSCK-A	1 with brake, 1 without brake			2.0	\$169.00

Adding 3" diameter swivel casters to your A-Frame Display Shelving System allows you to adapt your library space as your needs evolve.





































NOTE: A-Frame display shelving does not support ANY other accessories, aside from those listed above.

Tennsco also supplies these other product lines.



PROUDLY MADE IN THE U.S.A.

Quality Built Since 1962

PRODUCT LINE OVERVIEW										
STORAGE CABINETS	 Deluxe	 Standard	 Jumbo	 C-Thru	 Specialty					
BOOKCASES	 13 1/2" Deep	 18" Deep	 Cabinet/Bookcase Combo							
FILING	 Card & Multimedia	 Fixed Shelf Lateral File	 Lateral File	 Imperial Shelving	 Fixed Shelf Filing	 Lit. Sorter & 30 Drawers				
LOCKERS	 Standard	 Ventilated	 C-Thru	 Heavy-Duty	 Cubby					
SHELVING	 Bulk Rack	 ESP	 Q-Line	 Stur-D-Stor	 Regal	 Z-Line	 Record Archive	 Capstone	 L&T	 Estey Library
SHOP EQUIPMENT	 All Purpose Workbench	 Electronic Workbench	 Modular Workbench	 Modular/Mobile Tool Cart			 Foreman's Desk	 Service Cart	 Packing Table	

Additional Product Lines



esty[®]
Tomorrow's Shelving. Now.

Customer Service: (866) 446-8686 • customerservice@tennsco.com • www.esteys shelving.com



PROUDLY MADE IN THE U.S.A.