

POLICY AND SERVICES

PRICING: All prices are unassembled, F.O.B. Tennsco Corp's Facility in Dickson, Tennessee. All orders are subject to final acceptance at the Home Office, Dickson, Tennessee. Prices are subject to change without notice. Tennsco has the right to make product design changes at any time. Tennsco's prices do not include sales, use, excise or similar taxes. Consequently, in addition to the prices specified herein, the amount of any present or future sales, use, excise or similar tax applicable to the manufacture, sale, purchase or use of the goods sold hereunder shall be paid by Buyer. In lieu thereof, Buyer shall provide Seller with a tax exemption certificate acceptable to the applicable taxing authorities.

TERMS OF PAYMENT: Terms are Net 30 Days from date of shipment. A service charge of 1¹/₂% per month will be charged for overdue invoices.

MINIMUM ORDERS: Minimum order is \$15.00.

SPECIFICATIONS: Tennsco reserves the right to change any product specifications contained in this price list.

FREIGHT CHARGES: All shipments will be made freight collect unless otherwise specified. If freight is prepaid, it will be added to the invoice or billed separately, depending on arrangements. On shipments by parcel post, the postage will be added to the invoice. All routing will be done solely by the Home Office. If purchaser does not accept delivery of merchandise when ready for shipment, storage fees will be charged to the purchaser.

WEIGHT: Weights shown are approximate.

FREIGHT CLAIMS: Claims for shortages must be made in writing to the Home Office within 15 days from receipt of shipment. Claims for damaged or lost material must be filed with the carrier.

Caution: When you give delivering carrier a clear receipt for a shipment in which there is damaged merchandise or a shortage, the carrier is relieved of further responsibility. Claims for damage or shortage must be filed by you with the delivering carrier. Tennsco will not accept return of merchandise damaged in transit. Your claim is with the delivering carrier.

PARTIAL SHIPMENTS: Tennsco reserves the right to make delivery in installments unless otherwise expressly stated herein. All such installments shall be separately invoiced and paid for when due, without regard to subsequent deliveries. Delay in delivery of all installments shall not relieve Buyer of its obligations to accept remaining deliveries.

SHIPPING TIME: Shipping dates are estimates only, based on standard manufacturing times. Tennsco makes every effort to meet shipping date requests, but will not be held liable for missed shipping dates. Once items are shipped, Tennsco is not responsible for delays caused by the delivering carrier. This includes, but is not limited to, delays in installation proceedings due to slow delivery by carrier.

CANCELLATIONS & RETURNS: Orders for "Special" items are not subject to change or cancellation. No return merchandise will be accepted without written consent of the General Office, Dickson, Tennessee. All returned shipments are subject to a handling charge of 25% plus all transportation charges incurred by Tennsco unless Tennsco is at fault. Once production of "Special" items has begun, cancellation of order is subject to Tennsco approval. A 15% surcharge will be assessed to approved cancelled items.

CODE RESTRICTIONS: Local building codes vary. It is the purchaser's responsibility to determine that product installation is in accordance with local requirements.

LIMITED WARRANTY

Tennsco warrants goods purchased hereunder to be free of defects in materials and workmanship for a period of one (1) year from the date of shipment, hereunder. Tennsco's warranty shall not apply in the event goods are damaged as a result of misuse, abuse, neglect, accident, improper application, modification or repair by persons not authorized by Seller, where goods are damaged during shipment. UNLESS CONSIDERED UNENFORCEABLE OR UNLAWFUL UNDER APPLICABLE LAW:

- ALL IMPLIED WARRANTIES, INCLUDING BUT NOT LIMITED TO WARRANTIES OR MERCHANTABILITY AND FITNESS FOR A PARTICULAR PURPOSE ARE HEREBY EXCLUDED;
- BUYERS REMEDY, IF ANY, FOR ANY DEFECTIVE GOODS SHALL BE LIMITED TO A REFUND BY SELLER OR REPLACEMENT OF THE GOODS AT SELLER'S OPTION, AND SHALL IN NO EVENT INCLUDE DAMAGES OF ANY KIND, WHETHER INCIDENTAL, CONSEQUENTIAL OR OTHERWISE.

NO GOODS ACCEPTED FOR RETURN WITHOUT PRIOR APPROVAL. Seller shall have the right to inspect any goods claimed to be defective at Buyer's place of business or require Buyer to return the goods to Seller for inspection at Seller's premises. Transportation charges covering returned goods will be borne by Seller only if such goods are proven to be defective, are covered by this warranty and are returned within the warranty period stated above.

TENNSCO CORP.
Mailing Address: Shipping Address:
P.O. Box 1888 201 Tennsco Drive
Dickson, TN 37056-1888 Dickson, TN 37055

(615) 446-8000 (800) 251-8184 FAX: (800) 722-0134
Internet: www.tennsco.com E-Mail: Info@tennsco.com

ESTEY®

DIVISION OF TENNSCO CORP.

DESIGNER SERIES PRICE LIST

MAILING ADDRESS: SHIPPING ADDRESS:
Tennsco Corp. Tennsco Corp.
P.O. Box 1888 201 Tennsco Drive
Dickson, TN 37056-1888 Dickson, TN 37055

(615) 446-8000 * (800) 251-8184 * FAX: (800) 722-0134
Internet: www.tennsco.com E-Mail: Info@tennsco.com

EFFECTIVE JUNE 1, 2011

This price list supersedes all previous price lists.
Prices subject to change without notice.

CONTENTS:

- COVER: Color chart
PAGES 2-3: 36" wide units
PAGES 4-5: 36" wide divider units
PAGE 6: Periodical display units, upright extenders, seismic sway braces
PAGE 7: Uprights
PAGE 8: Shelves, brackets, dividers, top struts
PAGE 9: Cabinets, trays, newspaper and media racks, work shelf, Princeton file
PAGE 10: Display shelves, integral back and storage shelves, browsing boxes
PAGE 11: Reference, zig-zag & audio/visual shelves
PAGE 12: Book supports, fillers, backstops
PAGE 13: Wall hung columns, overhead bracing, wall clip, labeling accessories
PAGE 14: Canopy tops & accessories, lighting
PAGE 15: Gussets and fillers, backs
PAGE 16: End panels

STANDARD AND PREMIUM COLORS

Estey standard and premium colors are listed below. Special color matches can also be furnished. For pricing on premium and special colors, please contact factory.
NOTE: Antimicrobial coating available; contact factory.

STANDARD COLORS

Arctic White #061	Autumn White #564
Black #003	Champagne Putty #216
Dove Grey #074	Georgian Ivory #062
Light Grey #053	Medium Grey #002
Oyster #470	Pearl Grey #065
Sand #214	Sandstone #068

PREMIUM COLORS

Buff #034	Cloud Blue #517
Cocoa #103	Smoke #780
Teal #112	Wine #118

SINGLE FACE*

*All single face shelving must be wall anchored. Sway braces not included on single-face units.

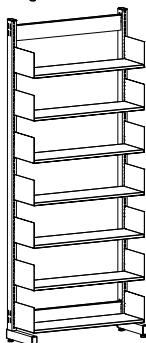
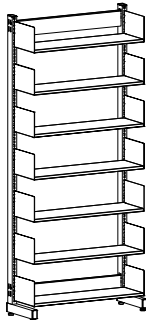
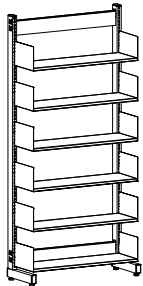
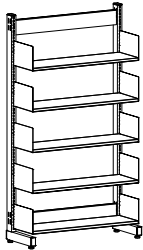

STARTER UNITS			ADDER UNITS			SHELF DEPTH	BASE DEPTH
CAT. NO.	WT.	PRICE	CAT. NO.	WT.	PRICE		
42" HIGH, 3 LEVELS							
ED41080S	54	518.00	ED41080A	44	398.00	8"	8"
ED41082S	56	520.00	ED41082A	46	400.00	8"	10"
ED41090S	56	536.00	ED41090A	46	409.00	9"	9"
ED41091S	58	539.00	ED41091A	47	412.00	9"	10"
ED41100S	59	521.00	ED41100A	49	403.00	10"	10"
ED41102S	62	541.00	ED41102A	51	414.00	10"	12"
ED41120S	65	545.00	ED41120A	54	418.00	12"	12"
66" HIGH, 5 LEVELS							
ED61080S	77	677.00	ED61080A	63	532.00	8"	8"
ED61082S	79	680.00	ED61082A	65	535.00	8"	10"
ED61090S	81	699.00	ED61090A	66	547.00	9"	9"
ED61091S	82	702.00	ED61091A	67	550.00	9"	10"
ED61100S	85	685.00	ED61100A	71	542.00	10"	10"
ED61102S	87	705.00	ED61102A	73	553.00	10"	12"
ED61120S	94	713.00	ED61120A	79	561.00	12"	12"
78" HIGH, 6 LEVELS							
ED71080S	88	758.00	ED71080A	72	600.00	8"	8"
ED71082S	91	760.00	ED71082A	74	602.00	8"	10"
ED71090S	93	780.00	ED71090A	76	616.00	9"	9"
ED71091S	94	782.00	ED71091A	77	618.00	9"	10"
ED71100S	98	766.00	ED71100A	81	611.00	10"	10"
ED71102S	101	786.00	ED71102A	83	622.00	10"	12"
ED71120S	109	796.00	ED71120A	91	632.00	12"	12"
84" HIGH, 7 LEVELS							
ED81080S	98	825.00	ED81080A	80	661.00	8"	8"
ED81082S	100	827.00	ED81082A	82	663.00	8"	10"
ED81090S	103	850.00	ED81090A	85	679.00	9"	9"
ED81091S	104	853.00	ED81091A	86	682.00	9"	10"
ED81100S	109	838.00	ED81100A	91	676.00	10"	10"
ED81102S	111	834.00	ED81102A	93	675.00	10"	12"
ED81120S	121	846.00	ED81120A	103	687.00	12"	12"
90" HIGH, 7 LEVELS							
ED91080S	100	837.00	ED91080A	81	667.00	8"	8"
ED91082S	102	839.00	ED91082A	83	669.00	8"	10"
ED91090S	105	840.00	ED91090A	86	674.00	9"	9"
ED91091S	106	845.00	ED91091A	87	677.00	9"	10"
ED91100S	111	850.00	ED91100A	92	682.00	10"	10"
ED91102S	114	870.00	ED91102A	94	693.00	10"	12"
ED91120S	123	882.00	ED91120A	104	705.00	12"	12"

24" and 30" wide units are also available. Contact factory for pricing and weights. For 24" units, add "2" to end of catalog number (e.g. ED81080S2); for 30" units, add "3" (e.g. ED81080S3).

DESIGNER SERIES UNITS 36" WIDE DOUBLE FACE

ESTEY
DIVISION OF TENNSCO CORP.

DOUBLE FACE

STARTER UNITS			ADDER UNITS			SHELF DEPTH	BASE DEPTH
CAT. NO.	WT.	PRICE	CAT. NO.	WT.	PRICE		
42" HIGH, 3 LEVELS							
ED42080S	78	701.00	ED42080A	67	571.00	8"	16"
ED42082S	81	706.00	ED42082A	70	576.00	8"	20"
ED42090S	82	695.00	ED42090A	71	573.00	9"	18"
ED42091S	84	700.00	ED42091A	73	578.00	9"	20"
ED42100S	87	710.00	ED42100A	76	583.00	10"	20"
ED42102S	91	722.00	ED42102A	79	591.00	10"	24"
ED42120S	98	730.00	ED42120A	86	599.00	12"	24"
66" HIGH, 5 LEVELS							
ED62080S	115	970.00	ED62080A	99	815.00	8"	16"
ED62082S	119	975.00	ED62082A	103	820.00	8"	20"
ED62090S	122	970.00	ED62090A	107	823.00	9"	18"
ED62091S	125	976.00	ED62091A	109	829.00	9"	20"
ED62100S	131	988.00	ED62100A	115	836.00	10"	20"
ED62102S	136	994.00	ED62102A	119	841.00	10"	24"
ED62120S	149	1,010.00	ED62120A	132	857.00	12"	24"
78" HIGH, 6 LEVELS							
ED72080S	133	1,106.00	ED72080A	116	938.00	8"	16"
ED72082S	137	1,111.00	ED72082A	119	943.00	8"	20"
ED72090S	142	1,107.00	ED72090A	124	948.00	9"	18"
ED72091S	144	1,113.00	ED72091A	126	954.00	9"	20"
ED72100S	152	1,129.00	ED72100A	134	964.00	10"	20"
ED72102S	156	1,141.00	ED72102A	138	972.00	10"	24"
ED72120S	172	1,161.00	ED72120A	154	992.00	12"	24"
84" HIGH, 7 LEVELS							
ED82080S	150	1,228.00	ED82080A	131	1,054.00	8"	16"
ED82082S	154	1,232.00	ED82082A	135	1,058.00	8"	20"
ED82090S	160	1,234.00	ED82090A	141	1,068.00	9"	18"
ED82091S	162	1,240.00	ED82091A	143	1,074.00	9"	20"
ED82100S	172	1,255.00	ED82100A	153	1,084.00	10"	20"
ED82102S	177	1,267.00	ED82102A	157	1,092.00	10"	24"
ED82120S	196	1,291.00	ED82120A	176	1,116.00	12"	24"
90" HIGH, 7 LEVELS							
ED92080S	152	1,240.00	ED92080A	132	1,060.00	8"	16"
ED92082S	158	1,244.00	ED92082A	137	1,064.00	8"	20"
ED92090S	162	1,246.00	ED92090A	142	1,074.00	9"	18"
ED92091S	167	1,252.00	ED92091A	145	1,080.00	9"	20"
ED92100S	176	1,261.00	ED92100A	155	1,087.00	10"	20"
ED92102S	179	1,273.00	ED92102A	158	1,095.00	10"	24"
ED92120S	199	1,297.00	ED92120A	177	1,119.00	12"	24"

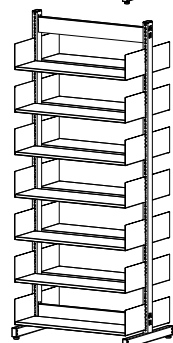
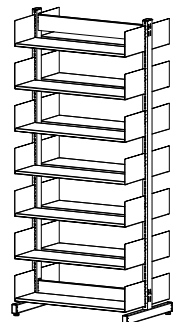
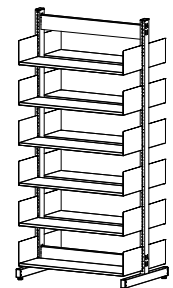
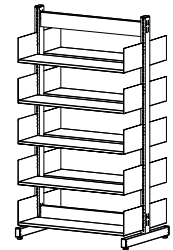
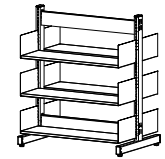

24" and 30" wide units are also available. Contact factory for pricing and weights.
For 24" units, add "2" to end of catalog number (e.g. ED82080S2); for 30" units, add "3" (e.g. ED82080S3).

SINGLE FACE*

*All single face shelving must be wall anchored. Sway braces not included on single-face units.

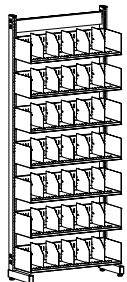
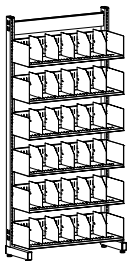
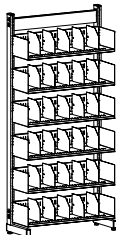
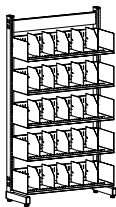

STARTER UNITS			ADDER UNITS			SHELF DEPTH	BASE DEPTH
CAT. NO.	WT.	PRICE	CAT. NO.	WT.	PRICE		
42" HIGH, 3 LEVELS							
DD41100S	76	646.00	DD41100A	66	528.00	10"	10"
DD41102S	78	671.00	DD41102A	67	544.00	10"	12"
DD41103S	80	686.00	DD41103A	70	558.00	10"	13"
DD41120S	80	684.00	DD41120A	70	557.00	12"	12"
DD41130S	83	704.00	DD41130A	72	576.00	13"	13"
DD41133S	88	717.00	DD41133A	77	597.00	13"	16"
66" HIGH, 5 LEVELS							
DD61100S	112	894.00	DD61100A	98	751.00	10"	10"
DD61102S	115	918.00	DD61102A	100	766.00	10"	12"
DD61103S	117	931.00	DD61103A	102	779.00	10"	13"
DD61120S	120	945.00	DD61120A	105	793.00	12"	12"
DD61130S	124	975.00	DD61130A	109	823.00	13"	13"
DD61133S	129	990.00	DD61133A	113	845.00	13"	16"
78" HIGH, 6 LEVELS							
DD71100S	131	1,017.00	DD71100A	114	862.00	10"	10"
DD71102S	133	1,041.00	DD71102A	116	877.00	10"	12"
DD71103S	136	1,056.00	DD71103A	119	891.00	10"	13"
DD71120S	140	1,074.00	DD71120A	123	910.00	12"	12"
DD71130S	144	1,112.00	DD71130A	127	947.00	13"	13"
DD71133S	150	1,127.00	DD71133A	132	969.00	13"	16"
84" HIGH, 7 LEVELS							
DD81100S	147	1,130.00	DD81100A	130	968.00	10"	10"
DD81102S	150	1,130.00	DD81102A	131	971.00	10"	12"
DD81103S	152	1,167.00	DD81103A	134	996.00	10"	13"
DD81120S	157	1,170.00	DD81120A	139	1,011.00	12"	12"
DD81130S	163	1,236.00	DD81130A	144	1,065.00	13"	13"
DD81133S	168	1,233.00	DD81133A	149	1,078.00	13"	16"
90" HIGH, 7 LEVELS							
DD91100S	150	1,142.00	DD91100A	131	974.00	10"	10"
DD91102S	152	1,166.00	DD91102A	132	989.00	10"	12"
DD91103S	154	1,235.00	DD91103A	135	1,030.00	10"	13"
DD91120S	160	1,206.00	DD91120A	140	1,029.00	12"	12"
DD91130S	165	1,304.00	DD91130A	145	1,099.00	13"	13"
DD91133S	170	1,249.00	DD91133A	150	1,086.00	13"	16"

All divider units come with 5 dividers per shelf.

24" and 30" wide units and additional heights are also available. Contact factory for pricing and weights. For 24" units, add "2" to end of catalog number (e.g. DD81100S2); for 30" units, add "3" (e.g. DD81100S3).

DESIGNER SERIES DIVIDER UNITS 36" WIDE DOUBLE FACE

ESTEY
DIVISION OF TENNSCO CORP.

DOUBLE FACE

STARTER UNITS			ADDER UNITS			SHELF DEPTH	BASE DEPTH
CAT. NO.	WT.	PRICE	CAT. NO.	WT.	PRICE		
42" HIGH, 3 LEVELS							
DD42100S	120	960.00	DD42100A	109	833.00	10"	20"
DD42102S	124	981.00	DD42102A	112	850.00	10"	24"
DD42103S	128	1,021.00	DD42103A	116	883.00	10"	26"
DD42120S	129	1,007.00	DD42120A	117	876.00	12"	24"
DD42130S	133	1,057.00	DD42130A	121	919.00	13"	26"
DD42133S	143	1,165.00	DD42133A	130	1,002.00	13"	32"
66" HIGH, 5 LEVELS							
DD62100S	186	1,405.00	DD62100A	170	1,253.00	10"	20"
DD62102S	190	1,421.00	DD62102A	173	1,268.00	10"	24"
DD62103S	195	1,467.00	DD62103A	178	1,304.00	10"	26"
DD62120S	201	1,473.00	DD62120A	184	1,320.00	12"	24"
DD62130S	208	1,553.00	DD62130A	191	1,390.00	13"	26"
DD62133S	219	1,661.00	DD62133A	200	1,473.00	13"	32"
78" HIGH, 6 LEVELS							
DD72100S	218	1,629.00	DD72100A	200	1,464.00	10"	20"
DD72102S	222	1,650.00	DD72102A	203	1,481.00	10"	24"
DD72103S	226	1,690.00	DD72103A	208	1,514.00	10"	26"
DD72120S	235	1,716.00	DD72120A	216	1,547.00	12"	24"
DD72130S	243	1,802.00	DD72130A	225	1,626.00	13"	26"
DD72133S	252	1,910.00	DD72133A	233	1,709.00	13"	32"
84" HIGH, 7 LEVELS							
DD82100S	249	1,839.00	DD82100A	230	1,668.00	10"	20"
DD82102S	253	1,860.00	DD82102A	233	1,685.00	10"	24"
DD82103S	258	1,900.00	DD82103A	238	1,718.00	10"	26"
DD82120S	269	1,939.00	DD82120A	249	1,764.00	12"	24"
DD82130S	279	2,037.00	DD82130A	259	1,855.00	13"	26"
DD82133S	289	2,145.00	DD82133A	268	1,938.00	13"	32"
90" HIGH, 7 LEVELS							
DD92100S	253	1,845.00	DD92100A	232	1,671.00	10"	20"
DD92102S	256	1,866.00	DD92102A	234	1,688.00	10"	24"
DD92103S	260	1,912.00	DD92103A	239	1,724.00	10"	26"
DD92120S	271	2,945.00	DD92120A	250	1,767.00	12"	24"
DD92130S	281	2,049.00	DD92130A	260	1,861.00	13"	26"
DD92133S	291	2,157.00	DD92133A	269	1,944.00	13"	32"

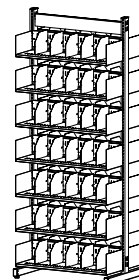
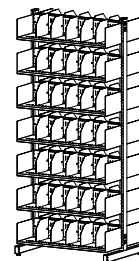
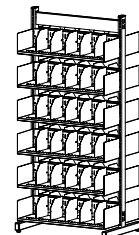
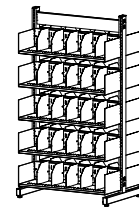
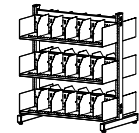

24" and 30" wide units and additional heights are also available. Contact factory for pricing and weights. For 24" units, add "2" to end of catalog number (e.g. DD82100S2); for 30" units, add "3" (e.g. DD82100S3).

All divider units come with 5 dividers per shelf.

PERIODICAL DISPLAY UNITS

Sloping periodical shelving with flat storage shelf. With 12" storage shelves & 12" base single face or 24" base double face.

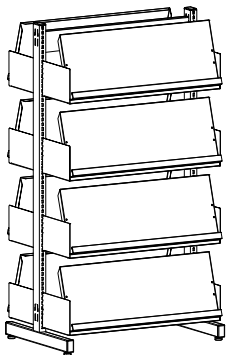
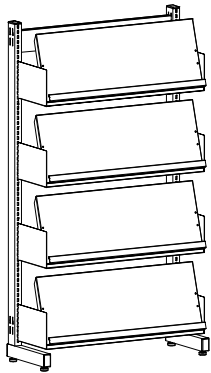

* All single face shelving must be wall anchored.

** Overhead top bracing recommended.

STARTER UNIT			ADDER UNIT			SLOPING STORAGE		W	D	H
CAT. NO.	WT.	PRICE	CAT. NO.	WT.	PRICE	SHELVES	LEVELS			
SINGLE FACE*										
DP41120S3	81	772.00	DP41120A3	70	645.00	3	3	30	12	42
DP61120S3	105	957.00	DP61120A3	91	805.00	4	4	30	12	66
DP71120S3	126	1,116.00	DP71120A3	109	952.00	5	5	30	12	78
DP81120S3	144	1,241.00	DP81120A3	126	1,082.00	6	6	30	12	84
DP91120S3	146	1,277.00	DP91120A3	127	1,100.00	6	6	30	12	90
DP41120S	89	772.00	DP41120A	79	645.00	3	3	36	12	42
DP61120S	116	957.00	DP61120A	102	805.00	4	4	36	12	66
DP71120S	139	1,116.00	DP71120A	122	952.00	5	5	36	12	78
DP81120S	160	1,241.00	DP81120A	142	1,082.00	6	6	36	12	84
DP91120S	162	1,277.00	DP91120A	143	1,100.00	6	6	36	12	90
DOUBLE FACE										
DP42120S3	131	1,184.00	DP42120A3	119	1,053.00	6	6	30	24	42
DP62120S3	173	1,498.00	DP62120A3	156	1,345.00	8	8	30	24	66
DP72120S3	208	1,799.00	DP72120A3	189	1,630.00	10	10	30	24	78
DP82120S3	243	2,081.00	DP82120A3	233	1,906.00	12	12	30	24	84
DP92120S3	246	2,087.00	DP92120A3	224	1,909.00	12	12	30	24	90
DP42120S	147	1,184.00	DP42120A	135	1,053.00	6	6	36	24	42
DP62120S	194	1,498.00	DP62120A	177	1,345.00	8	8	36	24	66
DP72120S	234	1,799.00	DP72120A	216	1,630.00	10	10	36	24	78
DP82120S	274	2,081.00	DP82120A	254	1,906.00	12	12	36	24	84
DP92120S**	277	2,087.00	DP92120A**	255	1,909.00	12	12	36	24	90

24" wide units are also available. Contact factory for pricing and weights.

SEISMIC SWAY BRACES

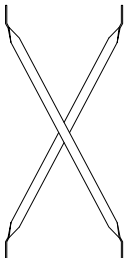

CAT. NO.	DESCRIPTION	W	D	H	WT.	PRICE
SSBR6030A	For 66" and 78" frames	30	1	58	4.5	64.00
SSBR7330A	For 84", 90" and 93" frames	30	1	73	5.9	81.00
SSBR6036A	For 66" and 78" frames	36	1	58	4.5	64.00
SSBR7336A	For 84", 90" and 93" frames	36	1	73	5.9	81.00

Provides support for uprights. Sway braces come in pairs, and include two turnbuckles with hooklegs.

UPRIGHT EXTENDER



CAT. NO.	W	D	H	WT.	PRICE
DUPTXT18A	—	2 1/2	18	3.7	100.00
DUPTXT24A	—	2 1/2	24	4.6	104.00
DUPTXT30A	—	2 1/2	30	5.6	108.00
DUPTXTxxA	—	2 1/2	Varies	Varies	contact factory

Add to existing frames for more space. Available in a variety of sizes with a 12" minimum. Contact factory for pricing & weights on sizes not shown.

DESIGNER SERIES UPRIGHTS

ESTEY
DIVISION OF TENNSCO CORP.

UPRIGHTS

SINGLE ENTRY				DOUBLE ENTRY			
CAT. NO.	WT.	DEPTH	PRICE	CAT. NO.	WT.	DEPTH	PRICE
42" HIGH							
EDSUPT4208	9.3	8"	112.00	EDDUPT4208	10.6	16"	122.00
EDSUPT4209	9.5	9"	119.00	EDDUPT4209	10.8	18"	114.00
EDSUPT4210	9.7	10"	110.00	EDDUPT4210	11.0	20"	119.00
EDSUPT4211	9.9	11"	121.00	EDDUPT4211	11.1	22"	119.00
EDSUPT4212	10.1	12"	119.00	EDDUPT4212	11.3	24"	123.00
EDSUPT4213	10.2	13"	120.00	EDDUPT4213	11.5	26"	130.00
EDSUPT4216	10.9	16"	112.00	EDDUPT4216	12.1	32"	155.00
66" HIGH							
EDSUPT6608	13.6	8"	137.00	EDDUPT6608	14.9	16"	147.00
EDSUPT6609	13.8	9"	144.00	EDDUPT6609	15.3	18"	139.00
EDSUPT6610	14.0	10"	135.00	EDDUPT6610	15.6	20"	144.00
EDSUPT6611	14.2	11"	146.00	EDDUPT6611	16.0	22"	144.00
EDSUPT6612	14.4	12"	144.00	EDDUPT6612	16.4	24"	145.00
EDSUPT6613	14.6	13"	144.00	EDDUPT6613	16.8	26"	155.00
EDSUPT6616	15.2	16"	137.00	EDDUPT6616	17.9	32"	180.00
78" HIGH							
EDSUPT7808	15.9	8"	150.00	EDDUPT7808	17.2	16"	160.00
EDSUPT7809	16.1	9"	156.00	EDDUPT7809	17.4	18"	151.00
EDSUPT7810	16.3	10"	147.00	EDDUPT7810	17.6	20"	157.00
EDSUPT7811	16.5	11"	158.00	EDDUPT7811	17.8	22"	157.00
EDSUPT7812	16.7	12"	156.00	EDDUPT7812	18.0	24"	161.00
EDSUPT7813	16.9	13"	157.00	EDDUPT7813	18.1	26"	168.00
EDSUPT7816	17.5	16"	150.00	EDDUPT7816	18.3	32"	193.00
84" HIGH							
EDSUPT8408	17.0	8"	156.00	EDDUPT8408	18.3	16"	166.00
EDSUPT8409	17.2	9"	163.00	EDDUPT8409	18.7	18"	158.00
EDSUPT8410	17.4	10"	154.00	EDDUPT8410	18.9	28"	163.00
EDSUPT8411	17.6	11"	165.00	EDDUPT8411	19.1	22"	165.00
EDSUPT8412	17.8	12"	151.00	EDDUPT8412	19.8	24"	167.00
EDSUPT8413	18.0	13"	163.00	EDDUPT8413	20.0	26"	174.00
EDSUPT8416	18.6	16"	147.00	EDDUPT8416	21.0	32"	199.00
90" HIGH							
EDSUPT9008	18.1	8"	162.00	EDDUPT9008	19.4	16"	172.00
EDSUPT9009	18.3	9"	158.00	EDDUPT9009	19.7	18"	164.00
EDSUPT9010	18.5	10"	160.00	EDDUPT9010	21.0	20"	166.00
EDSUPT9011	18.7	11"	171.00	EDDUPT9011	21.0	22"	167.00
EDSUPT9012	18.9	12"	169.00	EDDUPT9012	21.0	24"	170.00
EDSUPT9013	19.0	13"	197.00	EDDUPT9013	21.0	26"	180.00
EDSUPT9016	19.7	16"	155.00	EDDUPT9016	22.0	32"	205.00

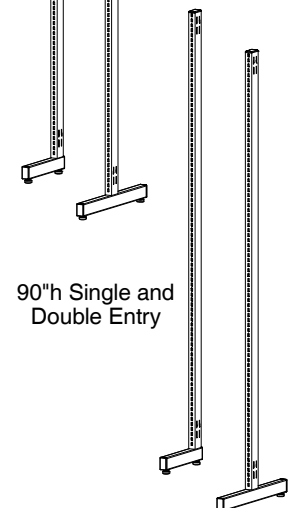
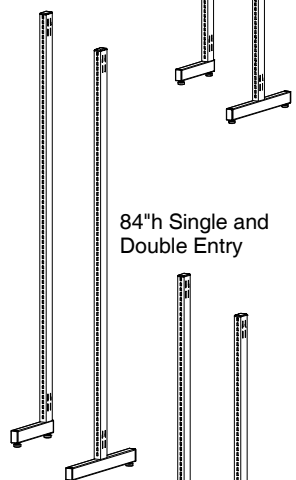
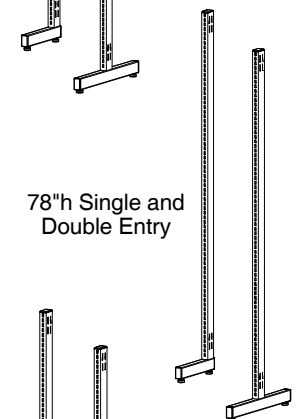
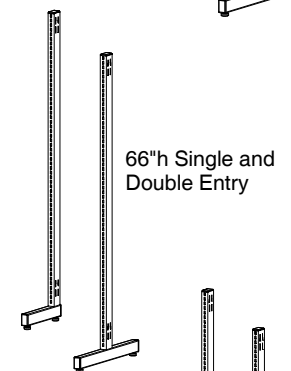
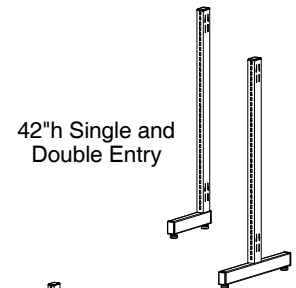

ADJUSTABLE SHELVES

CAT. NO.	W	D	H	WT.	PRICE
ED3008A	30	8	13/16	6.3	55.00
ED3009A	30	9	13/16	6.9	56.00
ED3010A	30	10	13/16	7.6	57.00
ED3011A	30	11	13/16	8.4	59.00
ED3012A	30	12	13/16	9.0	59.00
ED3013A	30	13	13/16	9.9	65.00
ED3014A	30	14	13/16	10.5	73.00
ED3016A	30	16	13/16	11.9	81.00
ED3608A	36	8	13/16	7.1	55.00
ED3609A	36	9	13/16	7.8	56.00
ED3610A	36	10	13/16	8.6	57.00
ED3611A	36	11	13/16	9.5	59.00
ED3612A	36	12	13/16	10.2	59.00
ED3613A	36	13	13/16	11.1	65.00
ED3614A	36	14	13/16	11.8	73.00
ED3616A	36	16	13/16	13.4	81.00

Includes shelf brackets. Can be furnished in additional widths or depths; contact factory for pricing.

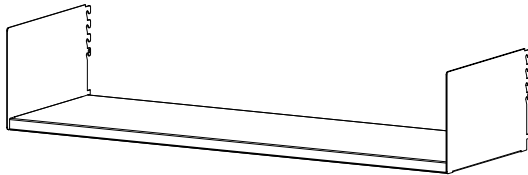

TOP STRUTS

CAT. NO.	W	D	H	WT.	PRICE
DSTRUT24	24	1	4 3/8	4.5	70.00
DSTRUT30	30	1	4 3/8	6.0	56.00
DSTRUT36	36	1	4 3/8	6.5	56.00

Used to connect two uprights.

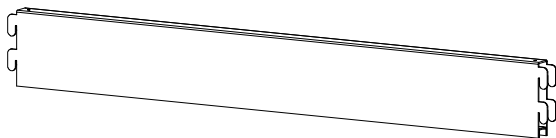

FLOOR ANCHOR

CAT. NO.	W	D	H	WT.	PRICE
DFLRANCH3	1	3	5/8	0.1	1.90

Used to aid in the leveling of fixed base units. Zinc finish.

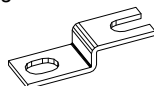

ADJUSTABLE DIVIDER SHELVES

CAT. NO.	W	D	H	WT.	PRICE
DDS3010A	30	10	13/16	12.8	99.00
DDS3011A	30	11	13/16	14.4	103.00
DDS3012A	30	12	13/16	14.9	106.00
DDS3013A	30	13	13/16	14.6	112.00
DDS3016A	30	16	13/16	20.0	141.00
DDS3610A	36	10	13/16	14.1	99.00
DDS3611A	36	11	13/16	15.9	103.00
DDS3612A	36	12	13/16	15.4	106.00
DDS3613A	36	13	13/16	16.1	112.00
DDS3616A	36	16	13/16	20.0	141.00

Slotted on 1" centers to accommodate dividers. Includes 5" back brackets, and 5 dividers per shelf.

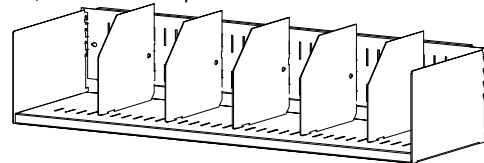

DIVIDERS

CAT. NO.	USE WITH	D	H	WT.	PRICE
DIV07	7" & 8" Shelves	7	6	0.4	2.10
DIV09	10" through 13"	9	7 1/2	0.7	3.30
DIV12	14" through 16"	12	7 1/2	1.0	4.70
SPD12	14" through 16"	9	12	1.6	9.60

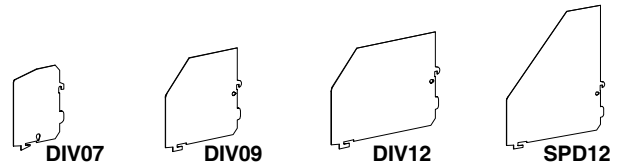

SHELF BRACKETS

CAT. NO.	W	D	H	WT.	PRICE
DSBRK08L*	1/4	8	7 1/2	1.1	17.50
DSBRK09L*	1/4	9	7 1/2	1.2	16.70
DSBRK10L*	1/4	10	7 1/2	1.3	16.10
DSBRK11L*	1/4	11	7 1/2	1.5	16.70
DSBRK12L*	1/4	12	7 1/2	1.6	15.60
DSBRK13L*	1/4	13	7 1/2	1.8	16.70
DSBRK14L*	1/4	14	7 1/2	1.9	19.90
DSBRK16L*	1/4	16	7 1/2	2.2	22.00

Attaches shelves to unit uprights. *NOTE: Listed catalog numbers are for left bracket only; for right bracket, change the suffix "L" to "R".



CABINETS

CAT. NO.	W	D	H	WT.	PRICE
CABINET ONLY					
FDCB36L	36	17 ⁵ / ₈	15 ¹ / ₂	53	1,051.00
CABINET WITH 1 PULL-OUT FRAME					
CBFD36LFA	36	17 ⁵ / ₈	15 ¹ / ₂	63	1,604.00
CABINET WITH 2 PULL-OUT FRAMES					
CBFD36L2FA	36	17 ⁵ / ₈	15 ¹ / ₂	73	2,156.00
FRAME ONLY					
FRAME36A	36	16	2	10.1	551.00

All welded construction. Ideal for storing valuable items that need to be secured. Includes flipper door and lock with two keys.

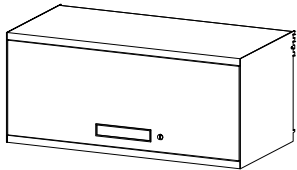

Cabinet Only

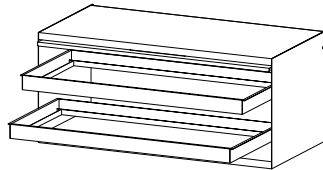

Cabinet With 2 Pull-Out Frames

PRINCETON FILE

CAT. NO.	W	D	H	WT.	PRICE
KDPRBOXA	36	16	16	41	467.00
KDPRBOX1PA	36	16	16	47	598.00

Displays periodicals while allowing for storage of back issues.

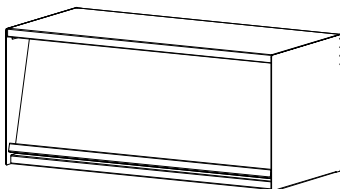

KDPRBOXA

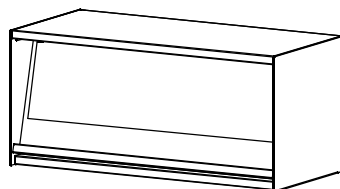

KDPRBOX1PA
(with Plexiglass front)

WORK SHELF AND BRACKETS

CAT. NO.	W	D	H	WT.	PRICE
LC54A	36	24	27 ¹ / ₂	30.0	761.00
LCL (Legs Only, Per Pair)				3.0	83.00
LCBRK24L (Left Bracket Only)				3.6	89.00
LCBRK24R (Right Bracket Only)				3.6	89.00

24" deep plastic shelf supported by two steel triangular brackets for work surface within shelving range. Must state desired finish of work shelf.

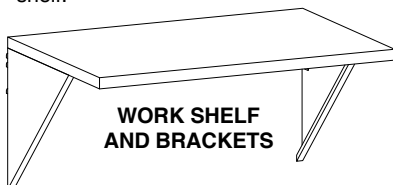

WORK SHELF
AND BRACKETS

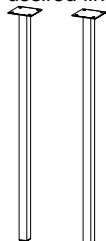

LEGS

METAL TRAYS

CAT. NO.	W	D	H	WT.	PRICE
FOR COMPACT DISCS					
TRCD514A	5	14 ³ / ₈	4 ¹ / ₂	4.4	318.00
CDD-1 (Divider Only)				0.2	20.00
FOR AUDIOCASSETTES					
TRAC414A	4 ⁷ / ₁₆	14 ³ / ₈	3 ¹ / ₈	3.3	345.00
ACD-1 (Divider Only)				0.2	31.00
FOR VHS TAPES					
TRVHS714A	7 ⁵ / ₈	14 ³ / ₈	3 ¹ / ₈	5.1	305.00
VHSD-1 (Divider Only)				0.3	23.00
FOR MICRO FICHE					
TRMF614A	6 ³ / ₁₆	14 ³ / ₈	3 ¹ / ₂	5.6	354.00
MFD-1 (Divider Only)				0.3	32.00
FOR 3x5 CARDS					
TRCRD3X5A	6 ³ / ₁₆	14 ³ / ₈	3 ¹ / ₂	3.9	402.00
CRDD-1 (Divider Only)				0.2	50.00

Handy metal trays store a wide variety of media. Use alone or in conjunction with Estey cabinets.

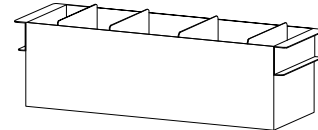

NEWSPAPER RACK

CAT. NO.	DESC.	W	D	H	WT.	PRICE
NPR6	6 Holders	36	12	14	9.6	719.00
NPR10	10 Holders	36	12	22	15.2	1,061.00

Displays newspapers. Newspaper sticks included.

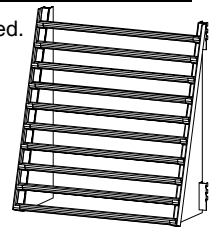
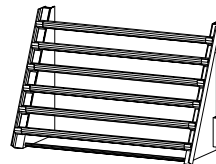

MEDIA HANGER RACK

CAT. NO.	W	D	H	WT.	PRICE
HB30A	30	6 ¹ / ₂	4 ¹ / ₄	2.1	63.00
HB36A	36	6 ¹ / ₂	4 ¹ / ₄	2.1	63.00

Consists of brackets with hanger rod for clear-view plastic media bags.



PERIODICAL DISPLAY SHELVES

CAT. NO.	W	D	H	WT.	PRICE
DPDS3012A	30	12	14	15.9	135.00
DPDS3612A	36	12	14	18.4	135.00
DPDS3012AC LH*	30	12	14	15.3	160.00
DPDS3612AC LH*	36	12	14	18.4	160.00
WITH PLEXIGLASS COVER					
DPDSCA30	30	12	14	22.0	224.00
DPDSCA	36	12	14	23.0	224.00

Sloped for display. 14" high periodical surface.
* Includes continuous label holder.

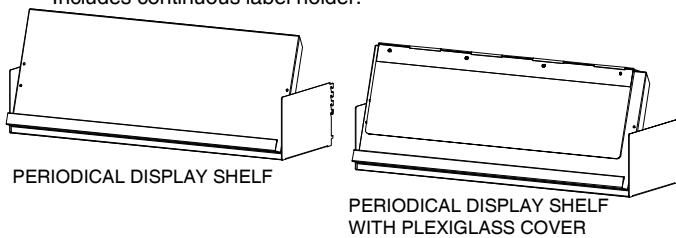

PERIODICAL DISPLAY SHELF

PERIODICAL DISPLAY SHELF
WITH PLEXIGLASS COVER

SLOPED DISPLAY SHELVES

CAT. NO.	W	D	H	WT.	PRICE
SDS3012A	30	12	12	7.3	61.00
SDS3612A	36	12	12	9.6	61.00
SDS3012AC LH*	30	12	12	13.1	94.00
SDS3612AC LH*	36	12	12	9.2	94.00
WITH PLEXIGLASS COVER					
SDSCA30	30	12	12	11.8	160.00
SDSCA	36	12	12	11.8	160.00

Sloped for display. Fixed or pivot optional. 12" periodical surface.
* Includes continuous label holder.

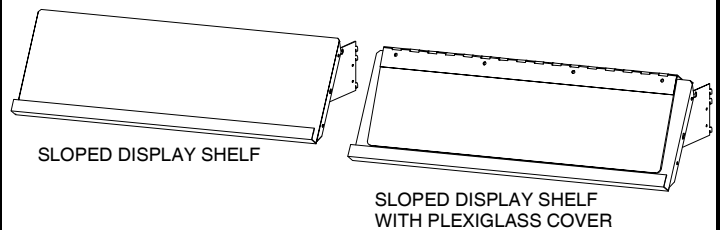

SLOPED DISPLAY SHELF

SLOPED DISPLAY SHELF
WITH PLEXIGLASS COVER

STORAGE SHELVES

CAT. NO.	W	D	H	WT.	PRICE
DIN3610A	36	10	13/16	7.0	34.00
DIN3612A	36	12	13/16	8.2	40.00
DIN3613A	36	13	13/16	8.7	46.00
DIN3614A	36	14	13/16	9.6	50.00
DIN3616A	36	16	13/16	10.6	54.00
DIN3618A	36	18	13/16	11.8	71.00
DIN3619A	36	19	13/16	12.5	79.00

Used with sloped display shelves, or any place where a flat shelf is desired. For 30" shelf, change "DIN36" to "DIN30" (e.g. DIN3010A).

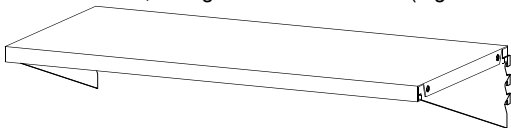

INTEGRAL BACK SHELVES

CAT. NO.	W	D	H	WT.	PRICE
DBLIB3608A	36	8	13/16	7.8	69.00
DBLIB3609A	36	9	13/16	8.5	69.00
DBLIB3610A	36	10	13/16	9.1	69.00
DBLIB3611A	36	11	13/16	10.1	73.00
DBLIB3612A	36	12	13/16	11.0	73.00
DBLIB3613A	36	13	13/16	11.7	79.00
DBLIB3616A	36	16	13/16	13.9	96.00

Built-in 2" backstop keeps items organized. Includes brackets and one wire divider per shelf. For 30" shelf, change "DBLIB36" to "DBLIB30" (e.g. DBLIB3016A).

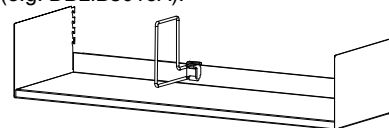

METAL BROWSING BOX

CAT. NO.	W	D	H	WT.	PRICE
BRB3005A	30	15 1/16	5 1/2	13.5	193.00
BRB3605A	36	15 1/16	5 1/2	15.3	193.00
BRBWD (Divider Only)				0.1	6.60

Ideal for storing all media items. Includes 2 wire dividers.

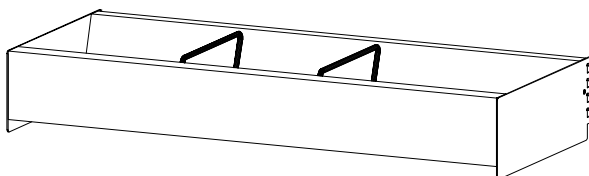

PULL-OUT BROWSING BOX

CAT. NO.	W	D	H	WT.	PRICE
XBRB3611A	36	12	5 1/2	30	369.00
XBRB3614A	36	15 1/16	5 1/2	32	373.00

Ideal for storing all media items in a high capacity environment. Multiple boxes can be placed on top of one another while retaining accessibility to stored items.

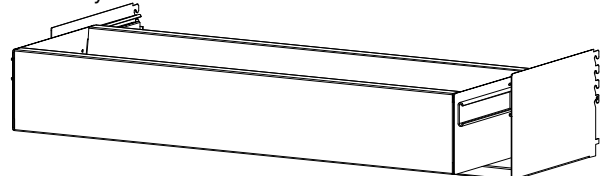

24" and 30" sizes also available; call factory for pricing and weights.

DESIGNER SERIES SPECIALTY SHELVES

ESTEY
DIVISION OF TENNSCO CORP.

SLIDING REFERENCE SHELVES

CAT. NO.	W	D	H	WT.	PRICE
DSRS3008A	30	8	3	13.7	238.00
DSRS3009A	30	9	3	16.0	216.00
DSRS3010A	30	10	3	19.6	245.00
DSRS3012A	30	12	3	23.0	237.00
DSRS3608A	36	8	3	15.1	238.00
DSRS3609A	36	9	3	17.7	216.00
DSRS3610A	36	10	3	13.5	245.00
DSRS3612A	36	12	3	8.0	237.00

Sturdy full extension slides attach to underside of adjustable shelf. Use two reference shelves for double face units.

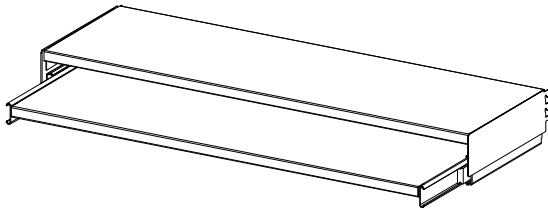

VIDEO CASSETTE/ PAPERBACK BOOK SHELF

CAT. NO.	W	D	H	WT.	PRICE
WITH NO SLOTS FOR DIVIDERS					
DVCS3609A	36	9	7 ¹ / ₂	9.9	71.00
DVCS3610A	36	10	7 ¹ / ₂	10.2	73.00
DVCS3612A	36	12	7 ¹ / ₂	12.2	80.00
WITH SLOTS AND FIVE DIVIDERS					
DDVCS3609A	36	9	7 ¹ / ₂	11.9	82.00
DDVCS3610A	36	10	7 ¹ / ₂	12.6	84.00
DDVCS3612A	36	12	7 ¹ / ₂	15.7	96.00
DIVIDER ONLY					
DIV07 (for 9" deep shelves only)				0.4	2.10
DIV09 (for 10" & 12" deep shelves only)				0.7	3.30

Slopes to allow convenient viewing of spines on paperbacks and video cassettes. 30" w size also available; call factory for pricing.

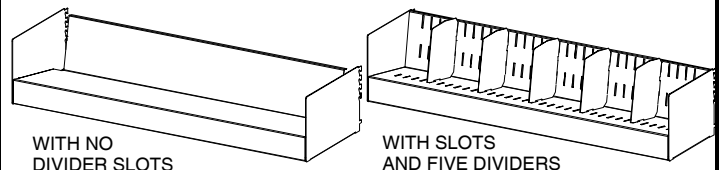

ZIG-ZAG SHELF

CAT. NO.	W	D	H	WT.	PRICE
DZZ3008A	30	7	5 ¹³ / ₁₆	10.1	88.00
DZZ3608A	36	7	5 ¹³ / ₁₆	10.9	88.00
INSERT ONLY					
ZZPD	36	18	5	3.8	54.00

Adjustable shelf with paperback insert. Ideal for displaying audio cassette or paperback books.

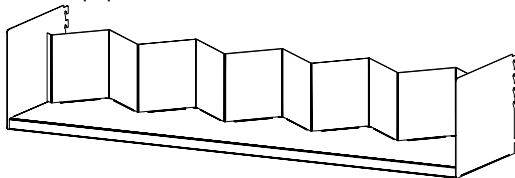

MICROFILM/ AUDIO CASSETTE SHELF

CAT. NO.	W	D	H	WT.	PRICE
DSPMF30A	30	10	7 ¹ / ₂	12.3	214.00
DSPMF36A	36	10	7 ¹ / ₂	12.3	214.00

For storing microfilm or audio cassettes. Capacity: 100 cassettes (36" w shelf).

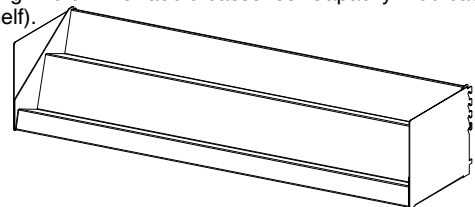

DOUBLE TIER BROWSING BOX

CAT. NO.	W	D	H	WT.	PRICE
DTBRB36A	36	16	8	21.0	309.00
WIRE DIVIDER					
DTWD	—	—	—	.2	4.40

Two levels of storage for all media items. Holds 168 cassette tapes, 56 VHS videotapes, or 156 compact discs.

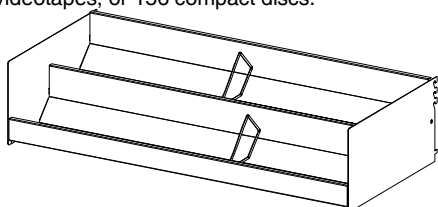

DOUBLE TIER VIDEO CASSETTE SHELF

CAT. NO.	W	D	H	WT.	PRICE
VCDT3014	30	14	12	20	155.00
VCDT3614	36	14	12	20	155.00

Use with compact discs, video cassettes, or paperbacks. Sloped; 36" wide shelf holds 60 VHS videotapes or 160 compact discs.

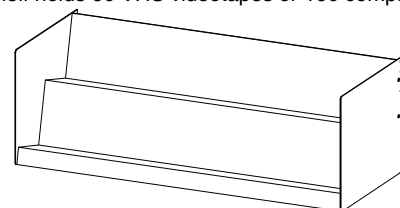

STEEL BOOK SUPPORTS

CAT. NO.	W	D	H	WT.	PRICE
WITH CORK BACKING					
BSN6	4 ⁹ / ₁₆	5 ¹ / ₂	6	0.6	5.40
BSN9	4 ⁹ / ₁₆	5 ¹ / ₂	9	1.1	6.60
WITH MAGNETIC STRIP					
BSM6	4 ⁹ / ₁₆	5 ¹ / ₂	6	1.0	5.40
BSM9	4 ⁹ / ₁₆	5 ¹ / ₂	9	1.1	6.60

Unattached book support used on surface of shelves. Furnished with cork backing or a magnetic strip, as specified above.

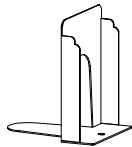

WIRE BOOK SUPPORTS

CAT. NO.	TYPE	W	D	H	WT.	PRICE
WBS6	"V"	3 ³ / ₁₆	—	6	0.2	2.70
WBS9	"V"	3 ³ / ₁₆	—	9	0.3	3.40
WBSW7	"W"	3 ³ / ₁₆	—	7	0.3	3.20
WBSW9	"W"	3 ³ / ₁₆	—	9	0.4	3.90

Heavy spring wire book support. Rubber tipped to prevent slippage. Attaches to underside of shelf. Easily adjustable.

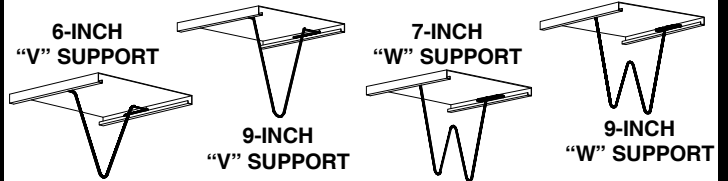

NOTE: Dividers are shown attached to shelves for clarification purposes only; shelves must be ordered separately.

HOOK-ON STEEL BOOK SUPPORT

CAT. NO.	W	D	H	WT.	PRICE
LOBS6	4 ⁹ / ₁₆	1 ³ / ₄	6	0.6	7.30
LOBS9	4 ⁹ / ₁₆	1 ³ / ₄	9	1.2	8.30

Hooks onto return flange of adjustable shelves for rigid support.

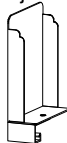

SHELF FILLER

CAT. NO.	W	D	H	WT.	PRICE
SHFIL30	27	2 ⁵ / ₈	1	2.3	27.00
SHFIL36	33	2 ⁵ / ₈	1	2.6	27.00

Fills the space between adjustable shelves on double sided units, providing a continuous surface. Attaches with two clips that fasten to underside of shelves.

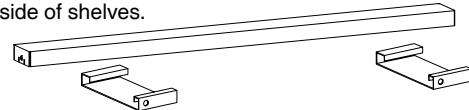

**REVERSIBLE BACKSTOP
& WIRE DIVIDER**

CAT. NO.	W	D	H	WT.	PRICE
RBS30 (backstop)	30	7 ⁷ / ₁₆	2	1.2	7.20
RBS36 (backstop)	36	7 ⁷ / ₁₆	2	1.3	7.20
BSWBS (wire divider)	—	8 ¹ / ₂	4	0.2	3.10

One side is a regular backstop. The other side is a sliding support backstop (when used with optional wire divider sold above).

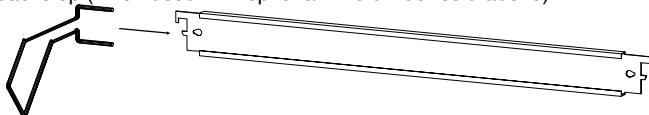

**KICK PLATE
FOR BASE**

CAT. NO.	W	D	H	WT.	PRICE
DKP24A	24	2 ¹ / ₂	1	1.1	17.50
DKP30A	30	2 ¹ / ₂	1	1.2	14.00
DKP36A	36	2 ¹ / ₂	1	1.6	14.00

Prevents items from rolling beneath shelves.

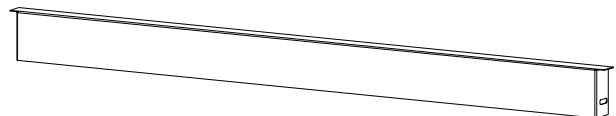

**OFFSET CENTER BACKSTOP
—LARGE PROFILE**

CAT. NO.	W	D	H	WT.	PRICE
CBS30	30	3 ³ / ₈	3 ⁹ / ₃₂	1.7	21.00
CBS36	36	3 ³ / ₈	3 ⁹ / ₃₂	2.1	21.00

Works as a backstop for each side of a double entry unit, eliminating the need for an individual backstop for each side.

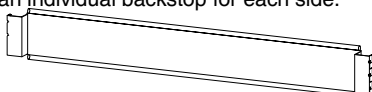

**OFFSET CENTER BACKSTOP
—SMALL PROFILE**

CAT. NO.	W	D	H	WT.	PRICE
CBSS30	30	7 ⁷ / ₁₆	2	1.4	9.20
CBSS36	36	7 ⁷ / ₁₆	2	1.6	9.20

Works as a backstop for each side of a double entry unit, eliminating the need for an individual backstop for each side.

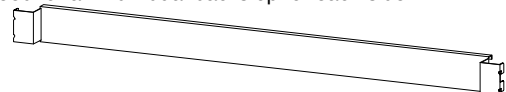

DESIGNER SERIES MISCELLANEOUS ACCESSORIES

ESTEY
DIVISION OF TENNSCO CORP.

WALL HUNG COLUMNS

CAT. NO.	W	D	H	WT.	PRICE
DPILWCH24	1 1/2	1	24	1.4	20.00
DPILWCH30	1 1/2	1	30	1.8	22.00
DPILWCH42	1 1/2	1	42	2.5	36.00
DPILWCH54	1 1/2	1	54	3.2	30.00
DPILWCH60	1 1/2	1	60	3.6	32.00
DPILWCH66	1 1/2	1	66	3.9	34.00
DPILWCH72	1 1/2	1	72	4.3	36.00
DPILWCH78	1 1/2	1	78	4.6	38.00
DPILWCH84	1 1/2	1	84	5.0	40.00
DPILWCH90	1 1/2	1	90	5.3	42.00



Slotted strip attaches to wall. Designed to accept all components or accessory items. Special heights are available. Hardware not included due to the variety of possible wall construction scenarios.

TRANSVERSE OVERHEAD TOP TIE BRACING

CAT. NO.	W	D	H	WT.	PRICE
OTBW9	96	2	7/8	5.7	29.00

Channel construction top tie furnished in 8 foot lengths. Recommended for added stabilization when bases and shelves are of equal depths.

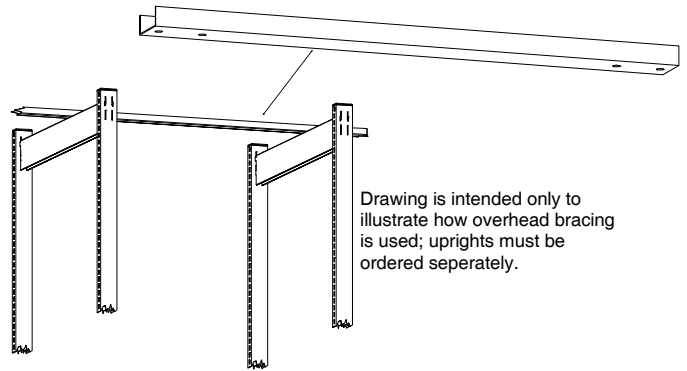

Drawing is intended only to illustrate how overhead bracing is used; uprights must be ordered separately.

WALL CLIP

CAT. NO.	W	D	H	WT.	PRICE
WCLIP	3	2	1	0.2	.99

Used to attach single face units to the wall for support.

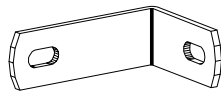

SHELF LABEL HOLDER

CAT. NO.	W	D	H	WT.	PRICE
SLH	5 1/2	—	3 3/4	0.1	.84

Plastic clip-on holder for 5/8" x 5" card.



CARD HOLDERS

CAT. NO.	W	D	H	WT.	PRICE
SINGLE CARD HOLDER					
SCH-B	5 1/4	—	3 1/8	0.1	2.50
DOUBLE CARD HOLDER					
DCH-B	10 1/4	—	3 1/8	0.2	4.20
ALUMINUM HOLDER					
SCH-CA	5 5/8	—	3 1/2	0.1	2.80

For 3" x 5" cards. Used on end panels. Attaches with double-sided tape. Steel holders are finished in black powder coat paint.



Single Card Holder
(steel)

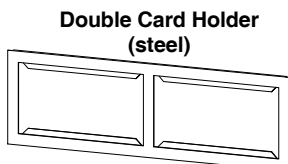

Double Card Holder
(steel)

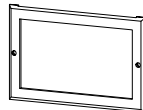

Aluminum
Holder

RANGE FINDER

CAT. NO.	W	D	H	WT.	PRICE
RFP6	—	6 3/4	3 1/8	0.2	4.50

For use on end panels or uprights for identification of range contents. Attaches with double-sided tape. Holds two 3" x 5" cards. Finished in black.

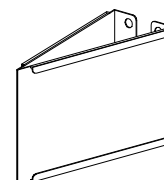

STEEL CANOPY TOPS

CAT. NO.	W	D	H	WT.	PRICE
SINGLE FACE					
DCTS3008	30	8	—	7.1	95.00
DCTS3009	30	9	—	7.5	88.00
DCTS3010	30	10	—	8.0	90.00
DCTS3012	30	12	—	8.8	95.00
DCTS3013	30	13	—	9.5	101.00
DCTS3016	30	16	—	11.3	118.00
DCTS3608	36	8	—	8.2	95.00
DCTS3609	36	9	—	8.7	88.00
DCTS3610	36	10	—	9.3	90.00
DCTS3612	36	12	—	10.3	95.00
DCTS3613	36	13	—	11.0	101.00
DCTS3616	36	16	—	13.1	118.00
DOUBLE FACE					
DCTD3016	30	16	—	13.2	167.00
DCTD3018	30	18	—	14.0	153.00
DCTD3020	30	20	—	15.0	157.00
DCTD3024	30	24	—	16.6	167.00
DCTD3026	30	26	—	18.0	179.00
DCTD3032	30	32	—	22.0	213.00
DCTD3616	36	16	—	15.1	167.00
DCTD3618	36	18	—	16.1	153.00
DCTD3620	36	20	—	17.3	157.00
DCTD3624	36	24	—	19.3	167.00
DCTD3626	36	26	—	21.0	179.00
DCTD3632	36	32	—	25.0	213.00
BRACKETS ONLY *					
DCTB08S (1 pair)	—	8	—	2.0	52.00
DCTB09S (1 pair)	—	9	—	2.0	42.00
DCTB10S (1 pair)	—	10	—	2.0	42.00
DCTB12S (1 pair)	—	12	—	2.0	44.00
DCTB13S (1 pair)	—	13	—	2.2	46.00
DCTB16S (1 pair)	—	16	—	2.8	58.00

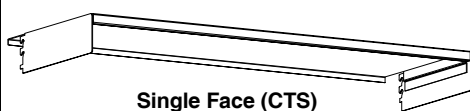

Single Face (CTS)

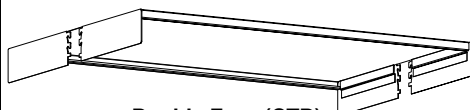

Double Face (CTD)

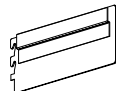

Brackets Only
1 pair
(left and right)

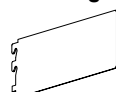

Keeps dust off your valuable materials. Includes attaching brackets.
* Attaching bracket is also used to secure steel end panels (see pages 38-39). Each pair consists of one left and one right bracket.

**CANOPY BRACKETS FOR
WOOD TOPS**

CAT. NO.	W	D	H	WT.	PRICE
DCTIB08S (1 pair)	8	—	—	1.2	37.00
DCTIB12S (1 pair)	12	—	—	1.9	39.00

Used when wood or hard plastic canopy tops are used. For single face units, use 1 pair. For double face units, use 2 pairs. Each pair consists of one left and one right bracket and hardware. Wood top not included.

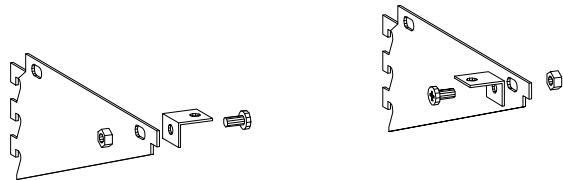

CANOPY SIGNAGE

CAT. NO.	W	D	H	WT.	PRICE
CPSGN36	35 ¹ / ₄	—	1 ³ / ₄	1.5	111.00

Easily identify special items or sections with this customizable label holder. Three attachment clips provided.

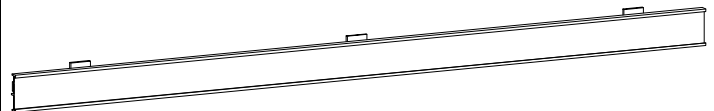

LIGHTING

CAT. NO.	W	D	H	WT.	PRICE
ESTLIGHT36	36	14	3 ⁵ / ₈	24.0	603.00

Place anywhere more light is needed for display or referencing. Includes: two F25TT8 cool white bulbs and acrylic lens in front for signage. Available in all standard colors.

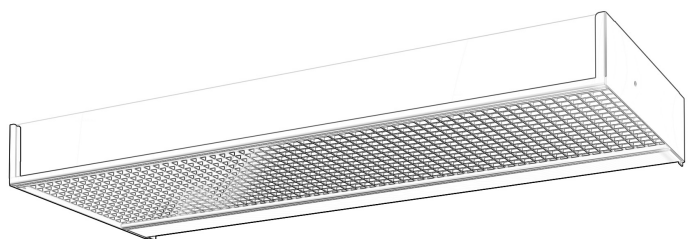

END PANELS—SINGLE FACE

CATALOG NUMBER	BASE DEPTH	HEIGHT	WT.	PRICE
DSP4208LA	8	42	9.2	126.00
DSP4209LA	9	42	9.8	124.00
DSP4210LA	10	42	10.4	127.00
DSP4212LA	12	42	11.5	133.00
DSP4213LA	13	42	12.3	137.00
DSP4216LA	16	42	14.4	151.00
DSP6608LA	8	66	13.8	148.00
DSP6609LA	9	66	14.7	147.00
DSP6610LA	10	66	15.7	151.00
DSP6612LA	12	66	18.0	161.00
DSP6613LA	13	66	18.6	166.00
DSP6616LA	16	66	21.0	184.00
DSP7808LA	8	78	16.1	158.00
DSP7809LA	9	78	17.2	158.00
DSP7810LA	10	78	18.3	163.00
DSP7812LA	12	78	21.0	174.00
DSP7813LA	13	78	22.0	180.00
DSP7816LA	16	78	25.0	201.00
DSP8408LA	8	84	17.3	163.00
DSP8409LA	9	84	18.4	163.00
DSP8410LA	10	84	18.4	168.00
DSP8412LA	12	84	22.0	180.00
DSP8413LA	13	84	23.0	187.00
DSP8416LA	16	84	27.0	209.00
DSP9008LA	8	90	18.4	168.00
DSP9009LA	9	90	19.7	169.00
DSP9010LA	10	90	21.0	174.00
DSP9012LA	12	90	24.0	187.00
DSP9013LA	13	90	25.0	194.00
DSP9016LA	16	90	29.0	217.00

*NOTE: Listed catalog numbers are for left panels only; for right panel, change the suffix "LA" to "RA".

Additional sizes available; call factory for pricing and weights.

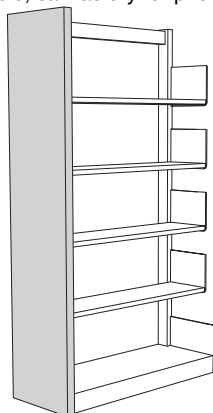

END PANELS—DOUBLE FACE

CATALOG NUMBER	BASE DEPTH	HEIGHT	WT.	PRICE
DDP4216A	16	42	16.4	213.00
DDP4218A	18	42	17.6	198.00
DDP4220A	20	42	15.9	202.00
DDP4224A	24	42	21.0	216.00
DDP4226A	26	42	21.0	228.00
DDP4232A	32	42	28.0	268.00
DDP6616A	16	66	23.0	244.00
DDP6618A	18	66	25.0	233.00
DDP6620A	20	66	27.0	243.00
DDP6624A	24	66	29.0	260.00
DDP6626A	26	66	32.0	275.00
DDP6632A	32	66	40.0	324.00
DDP7816A	16	78	27.0	260.00
DDP7818A	18	78	29.0	250.00
DDP7820A	20	78	31.0	261.00
DDP7824A	24	78	35.0	283.00
DDP7826A	26	78	38.0	298.00
DDP7832A	32	78	44.0	352.00
DDP8416A	16	84	28.0	267.00
DDP8418A	18	84	31.0	258.00
DDP8420A	20	84	34.0	270.00
DDP8424A	24	84	38.0	293.00
DDP8426A	26	84	40.0	310.00
DDP8432A	32	84	49.0	365.00
DDP9016A	16	90	30.0	275.00
DDP9018A	18	90	33.0	264.00
DDP9020A	20	90	35.0	275.00
DDP9024A	24	90	40.0	303.00
DDP9026A	26	90	43.0	321.00
DDP9032A	32	90	52.0	379.00

Additional sizes available; call factory for pricing and weights.



DESIGNER SERIES GUSSETS AND FILLERS

ESTEY
DIVISION OF TENNSCO CORP.

REINFORCING GUSSETS

CAT. NO.	W	D	H	WT.	PRICE
SINGLE FACE					
DGS08AL (left)	1/16	8	39 ⁷ / ₈	4.3	54.00
DGS08AR (right)	1/16	8	39 ⁷ / ₈	4.3	54.00
DGS09AL (left)	1/16	9	39 ⁷ / ₈	4.9	58.00
DGS09AR (right)	1/16	9	39 ⁷ / ₈	4.9	58.00
DGS10-1AL (left)	1/16	10	39 ⁷ / ₈	5.3	62.00
DGS10-1AR (right)	1/16	10	39 ⁷ / ₈	5.3	62.00
DGS12-1AL (left)	1/16	12	39 ⁷ / ₈	6.1	69.00
DGS12-1AR (right)	1/16	12	39 ⁷ / ₈	6.1	69.00
DGS13AL (left)	1/16	13	39 ⁷ / ₈	7.1	72.00
DGS13AR (right)	1/16	13	39 ⁷ / ₈	7.1	72.00
DGS16AL (left)	1/16	16	39 ⁷ / ₈	7.7	82.00
DGS16AR (right)	1/16	16	39 ⁷ / ₈	7.7	82.00

Used when additional stabilization is required.

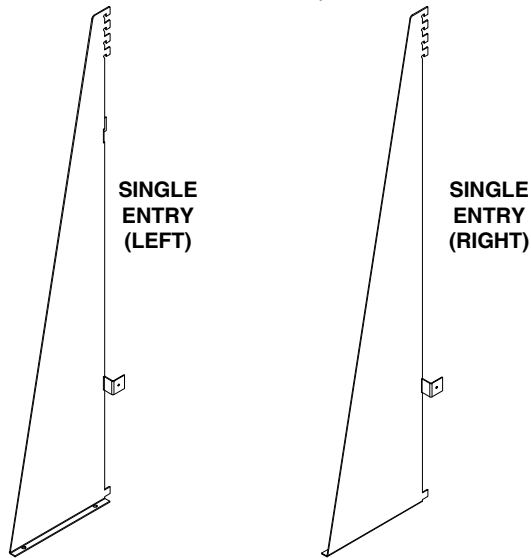

STEEL BACKS

CAT. NO.	W	D	H	WT.	PRICE
DNB3042A	30	1	42	12.3	132.00
DNB3066A	30	1	66	22.0	188.00
DNB3078A	30	1	78	25.0	214.00
DNB3084A	30	1	84	21.0	228.00
DNB3090A	30	1	90	30.0	241.00
DNB3642A	36	1	42	22.0	132.00
DNB3666A	36	1	66	14.7	188.00
DNB3678A	36	1	78	36.0	214.00
DNB3684A	36	1	84	36.0	228.00
DNB3690A	36	1	90	36.0	241.00

24" wide backs are also available. Contact factory for pricing and weights.

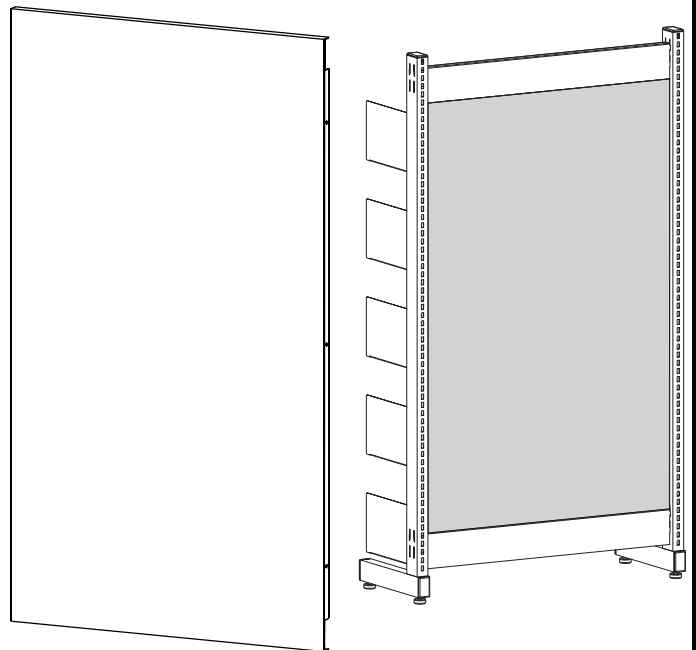

CORNER FILLERS

CAT. NO.	HEIGHTS	DEPTHS	WT.	PRICE
SCF <hhdd< h="">A</hhdd<>	42" to 93"	8" to 32"	Call Factory	

Used to make a corner for units placed at right angles to each other. Available in all heights and depths. Specify height and depth (*hhdd*) when ordering. Over 93" high contact factory.

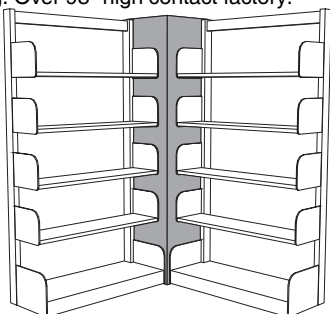

INTERMEDIATE WALL FILLERS

CAT. NO.	HEIGHTS	DEPTHS	WT.	PRICE
DCF <hhdd< h="">A</hhdd<>	42" to 93"	8" to 32"	Call Factory	

Used to fill a void where two single faced units are joined at a right angle with a double faced unit. Available for all base shelf depths and frame heights. Specify height and depth (*hhdd*) when ordering. Over 93" high contact factory.

